



Dependable Products From People You Trust



Differential Sticking Tester

Part No. 150-50

Instruction Manual

Updated 4/2/2025

Ver. 5

OFI Testing Equipment, Inc.

11302 Steeplecrest Dr. · Houston, Texas · 77065 · U.S.A.

Tele: 832.320.7300 · Fax: 713.880.9886 · www.ofite.com

Table of Contents

Intro.....	2
Description.....	2
Components	3
Safety.....	5
Test Procedure	6
<i>Timed Filtration</i>	<i>6</i>
Disassembly	11
Theory.....	12
<i>Example</i>	<i>14</i>
<i>Worksheet.....</i>	<i>15</i>
Maintenance.....	16
Diagrams	17
<i>Full Unit.....</i>	<i>17</i>
<i>Cell Assembly</i>	<i>18</i>
Warranty and Return Policy	19

Intro

The OFITE Differential Sticking Tester measures the “Stuck Pipe Tendency Coefficient” of drilling fluids, and also determines how effective lubricants or treatments might be with any given drilling fluid. This coefficient takes into account both the friction, or “stickiness”, of the filter cake, as well as the amount of cake building that must occur in order to freeze or stick the pipe in the hole. The coefficient is determined by running a Timed Filtration test. By measuring the area of cake building during a test, the “Bulk Sticking Coefficient” is obtained and read directly at the conclusion of the test. How likely a given fluid will be to produce a stuck pipe situation and how effective a given treatment may be, can be immediately determined on-site.

Description

The unit is normally pressurized by a CO₂ pressuring assembly, but any nitrogen source will also work. If nitrogen is used, the tester apparatus must be fitted with a suitable nitrogen regulator, gauges, valves, and high-pressure hoses. The standard test uses 477.5 psi (3,291 kPa) applied to a 200 mL stainless steel vessel. The unit includes both a flat-faced plate and a plate of 12½" (31.75 cm) spherical radius, which simulates the pipe inside the casing or collars in the borehole. For samples that adhere more to the plate than to the filter paper, stainless steel micro-corrugation disks are provided. For convenience a stainless steel carrying case is available as an optional item.

Components

#130-10-52	Jam Nut, 3/8-24, Qty: 2
#142-56	O-ring
#150-52	Neoprene Gasket
#150-53	Plastic Gasket
#150-54	Torque Wrench
#150-55	Spanner Wrench
#150-56	Test Cell O-ring
#150-57	5/16" Socket with 3/8" Drive
#150-58	Torque Plate, Flat Bottom
#150-59	Torque Plate, Spherical
#153-16	Glass Graduated Cylinder, 25 mL × 3/10 mL
#170-04	CO₂ Pressurization Unit:
#143-02-10	CO ₂ Puncture Head Assembly
#143-03	Barrel for CO ₂ Cartridge
#170-08	Regulator
#170-20	Manifold Block
#170-32	1/8" × 1/8" NPT Male Needle Valve
#171-22	Retainer Pin
#171-34	1500-PSI Gauge, 2", 1/4" NPT Bottom
#170-13-3	Test Cell O-ring, Viton 75D
#170-15	Base
#170-16	Valve Stem, Qty: 2
#170-17	Valve Stem O-ring, Qty: 10
#170-19	2 1/2" (6.35 cm) Filter Paper, Specially Hardened for Filter Presses
#170-35	6" Adjustable Wrench
#170-44	1/2" Rubber Foot, Qty: 4
#171-79	1/4" Hex Wrench

Optional:

#150-50-SP Spare Parts for #150-50:

- #142-56 O-ring, Qty: 12
- #143-02-13 O-ring for Puncture Pin Holder Assembly, CO₂ Cartridge, Qty: 4
- #143-02-14 O-ring for Puncture Pin Holder Assembly, Qty: 4
- #143-05 EZ Puncture CO₂ Bulbs, 8-Gram, UN #1013, Package of 10, Qty: 20
- #143-22 Gasket for Puncturing Pin, Qty: 6
- #150-51 Locking Mesh Disc, Qty: 10
- #150-52 Neoprene Gasket, Qty: 10
- #150-53 Plastic Gasket, Qty: 8
- #153-16 Glass Graduated Cylinder, 25 mL × $\frac{3}{10}$ mL, Qty: 2
- #170-13-3 Test Cell O-ring, Viton 75D, Qty: 4
- #170-16 Valve Stem, Qty: 2
- #170-17 Valve Stem O-ring, Qty: 20
- #170-19 2½" (6.35 cm) Filter Paper, Specially Hardened for Filter Presses, Qty: 5
- #170-23 60-Mesh Screen, Qty: 4
- #171-23-1 Safety Pin with Lanyard
- #171-79 Hex Wrench, ¼"

Safety

Nitrogen must be supplied in an approved Nitrogen Gas Cylinder and secured to meet safety standards. Do not use nitrous oxide cartridges as pressure sources.

Due to the high pressures involved in this test, extreme care must be exercised at all times. All safety precautions must be met, especially in the cell breakdown procedure after the filtration procedure has been completed.

Never transport CO₂ bulbs or cartridges by airplane without proper packaging. Cabin depressurization could cause them to explode.

Before pressuring, always check to be sure the regulator is in a closed position by ensuring the T-screw is backed out and free turning. Insert and puncture the CO₂ cartridge by turning the barrel only a quarter turn past the actual puncture point. Adjust the regulator to the desired pressure with the regulator T-screw. With the Differential Sticking Tester, never exceed 500 psi (3,450 kPa). When depressurizing, shut off the pressure supply, then bleed off the system of pressure with the valve, and finally back out the regulator T-screw.

Test Procedure

Timed Filtration

Two torque plates are provided with the unit. The spherical torque plate (#150-59) has a very slight curve on the bottom. The radius of the curve is 12.5" (31.75 cm) and simulates a 25" (63.5 cm) diameter drill casing or collar. The flat torque plate (#150-58) is completely flat across the surface. The difference between the two is sometimes difficult to see. To distinguish between the two, place them next to each other on a flat surface. The spherical torque plate will rock slightly, while the flat torque plate will sit firmly.

1. Make sure the unit is clean and dry before beginning a test.
2. Open the test cell. Remove the inner cap by turning the cell over and removing the two allen screws with the supplied wrench.
3. Inspect the o-ring on the bottom of the inner cap. Replace it if it shows signs of wear or damage.

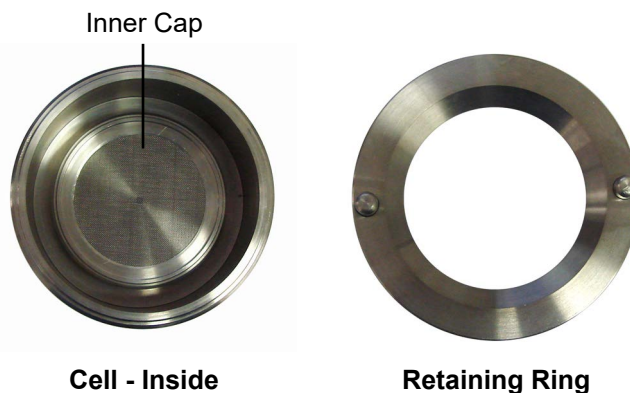
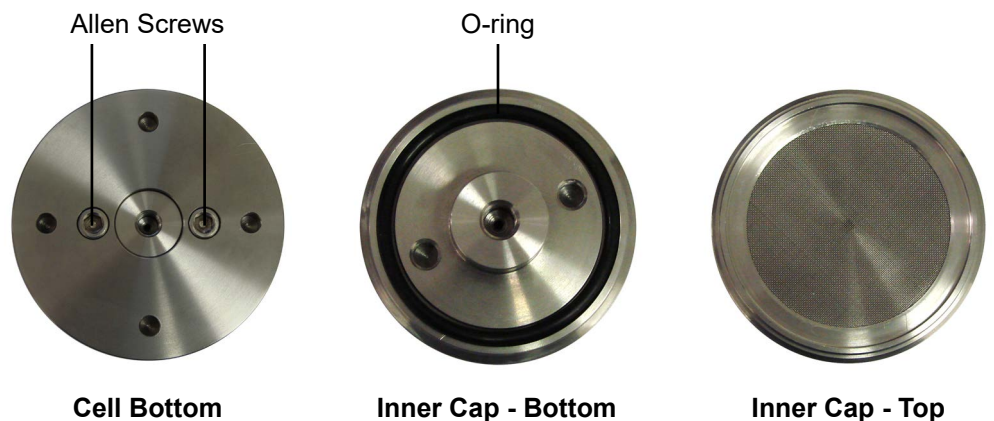



Tip

4. Place a sheet of filter paper on top of the screen on the inner cap. On top of the filter paper, place the rubber gasket, then the plastic ring.

The locking mesh disk can be used to lock the filter cake to the paper so that it does not stick to the torque plate face and break loose from the filter paper. If you choose to use the locking mesh disk, place it on top of the filter paper, beneath the rubber gasket.

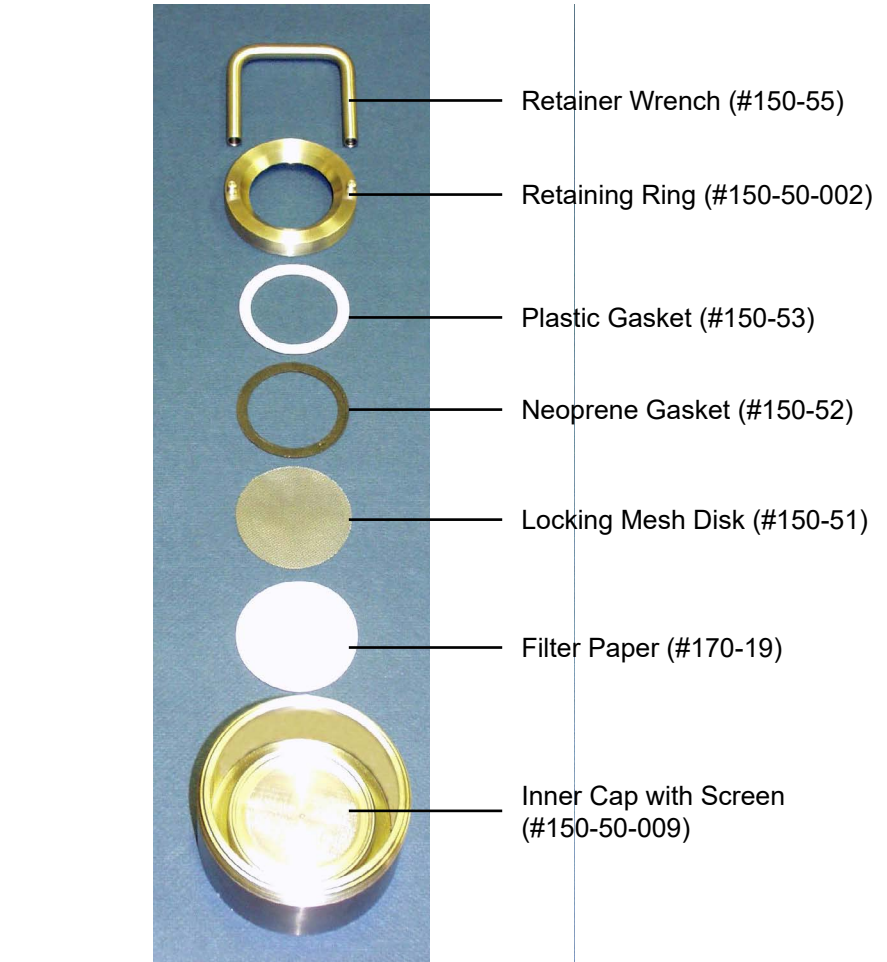

5. Screw the retaining ring in place on top of the filter paper and gaskets. Be sure to keep the gaskets centered.
6. Place the inner cap back into the cell. Make sure the o-ring seats properly beneath the inner cap. Refer to the photos on page 8.
7. Turn the cell over and secure the inner cap with the two allen screws.
8. Tighten the retaining ring securely with the supplied retainer wrench.
9. Inspect the o-rings on the valve stems and replace any that show signs of wear or damage. Screw one of the valve stems into the hole in the base of the test cell and hand tighten.

10. Place the cell on the stand. Make sure the four holes in the base of the cell line up with the stand tips.
11. Fill the cell with sample fluid to the scribed line.
12. Insert the stem of the torque plate through the hole in the cell cap as far as possible. The face of the plate should be facing towards the inside of the cell. Be careful not to cut the o-ring.



Torque Plate

13. Screw the cell cap onto the test cell body. Make sure the o-ring is properly seated in the groove in the cell cap.
14. Tighten the cell cap using the supplied spanner wrench. For additional leverage, place the lever arm horizontally between the two support legs.



Tip

Once the cell cap is tightened, rotate the cell on the stand until the valve stem hole is oriented away from the stand supports. This will provide more space for the torque lever.

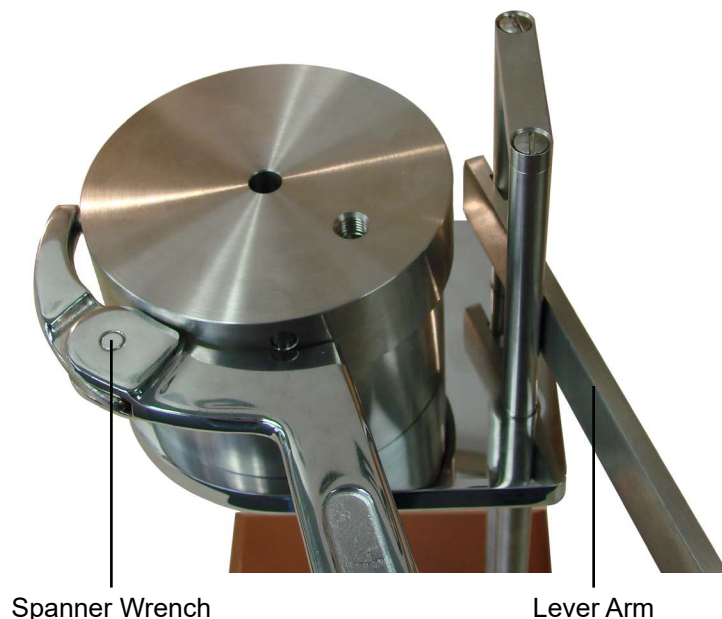

15. Screw the other valve stem into the hole in the cell cap and hand tighten.
16. Place the CO₂ assembly onto the top valve stem and secure it in place with the retaining pin.
17. Unscrew (counter-clockwise) the regulator T-screw until it turns freely.
18. Remove the barrel from the regulator. Place a CO₂ cartridge into the barrel and tighten the barrel to the puncture head until the cartridge punctures.
19. Tighten (clockwise) the regulator T-screw until the gauge reads 477.5 psi (3,292 kPa).
20. Place the 25 mL graduated cylinder under the cell and open the lower valve stem by turning it counter-clockwise ¼ turn.
21. Make sure the torque plate is up as far as possible by turning and pulling it upward.
22. Open the top valve stem ¼ turn to initiate filtration. Record the time of the start of the test.
23. Continue filtration for 10 minutes, or until the desired filtrate volume is collected.
24. Align the groove in the lever under the column top cross support and press the torque plate down into the cell. Continue to hold the torque plate all the way down against the screen until the pressure equalizes sufficiently to allow the plate to stick. This usually takes about two minutes and will require 50 to 80 pounds (23 to 36 kg) of force on the end of the lever.

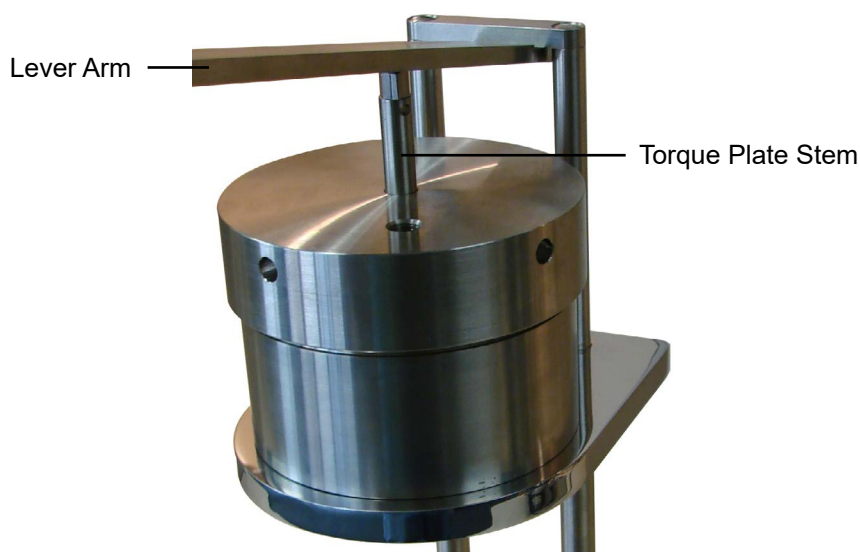



25. Record the filtrate volume.
26. Allow the torque plate to stick in the down position for 10 minutes.
27. Remove the lever and attach the socket to the torque wrench. Place the torque wrench and socket on the hex top of the torque plate stem. Wedge the lever between the columns above the cell platform so it can be used as a counter-torque lever.

If the filter paper tears when the torque plate is rotated, cell pressure will be lost through the valve stem. A standard HTHP Filter Press back pressure receiver may be substituted for the graduated cylinder while the torque readings are being taken. A length of rubber or tygon tubing can also be attached to the valve stem with the outlet end attached to a closed container.

28. Measure the torque by rotating the torque plate in either direction with the torque wrench. Observe the dial reading.
29. Repeat the torque measurements three to six times, allowing 30 seconds between each check. Record each reading.
30. Calculate the average torque reading and record the plate sticking time.

Disassembly

1. Turn the regulator T-handle counter-clockwise until the pressure gauge reads 0. Once the T-handle turns freely, open the bleeder valve.
2. Unscrew the barrel on the CO₂ assembly and remove the empty cartridge.
3. Remove the torque wrench and socket from the test cell.
4. Remove the CO₂ pressure assembly from the top valve stem.
5. Slowly open the valve stem to relieve any remaining pressure inside the test cell.
6. Remove the cell cap. If the torque plate remains in the cell cap, carefully push it through the lid by the stem.
7. Empty the test cell.
8. Gently wash the sample from the edge of the torque plate.
9. Note the diameter of the depression from the torque plate. If this diameter is less than 2 inches or if any cake is adhering to the edge of the torque plate, estimate the edge height of the cake from the filter paper.



If the cake is stuck to the torque plate rather than to the filter paper, then the test is invalid. Repeat the test using the locking mesh.

10. Using the retainer wrench, unscrew the retaining ring. Remove the slip ring and gasket. Remove the locking mesh, filter paper, and filter cake. Examine the filter cake as desired and note any observations.
11. Remove the cell from the stage and thoroughly clean all parts. Polish any surface where corrosion is noted.
12. Check all o-rings for damage or wear and replace as needed. Lubricate all o-rings with grease.

Theory

Bulk Sticking Coefficient (K_{sc}) Derivation:

The Bulk Sticking Coefficient (K_{sc}) is the ratio of the force necessary to initiate sliding of the plate (F_s) to the normal force on the plate (F_n).

Where:

T_u = Average of readings from Torque Wrench (inch-pounds)

r = Radius of Plate (inches)

h = Height above flat surface of cake around the edge of the plate (inches)

P = Cell Pressure (PSI), differential (inlet to outlet)

F_s = Sliding force

F_n = Normal force on plate

K_{sc} = Bulk Sticking Coefficient

K_{st} = Stuck Tendency Coefficient

a. The Sliding Force (F_s):

The Sliding Force (F_s) is a function of the measured torque (T_u). This equation should only be used when the radius is 1 and edge effects are not being considered.

$$F_s = 1.5 \times T_u$$

b. The normal force (F_n):

The Normal Force (F_n) is determined by multiplying the area by the differential pressure. This assumes that a pressure of 477.5 PSI was used during the test.

$$F_n = 1,500 \times r^2$$

If you are considering edge effects:

$$F_n = 1500 \times (1 + 4/3h)$$

c. The Bulk Sticking Coefficient (K_{sc})

The Bulk Sticking Coefficient (K_{sc}) is calculated by dividing the Sliding Force (F_s) by the Normal Force (F_n): $K_{sc} = F_s / F_n$

Ignoring Edge Effects:

$$= 1.5 T_u / \pi Pr^3$$

For a standard pressure of 477.5 PSI (3,292 kPa):

$$K_{sc} = 1.5 T_u / 1,500 r^3 = .001 \times T_u / r^3$$

And for $r = 1$ ":

$$K_{sc} = .001 \times T_u$$

Taking into account Edge Effects:

$$K_{sc} = F_s / F_n = (1.5 T_u / r) / (\pi Pr^2 + 4/3\pi rhP)$$

$$= (1.5T_u) / [\pi Pr^2 \times (r + 4/3h)]$$

For a standard pressure of 477.5 PSI (3,292 kPa) and $r = 1$ ":

$$K_{sc} = (1.5 \times T_u) / [1,500 \times (1 + 4/3h)]$$

$$K_{sc} = (.001 \times T_u) / (1 + 1.33h)$$

The Stuck Tendency Coefficient (K_{st}) is equal to the Bulk Sticking Coefficient (K_{sc}) multiplied by the variable stuck area.

$$K_{st} = K_{sc} \times (\text{Variable Stuck Area}) = T_u$$

K_{st} is not valid for the flat plate because the stuck area is either 0 or 3.14 in² ($r = 1$) and not a variable.



Note

Theory

Example

The drilling fluid sample is mixed and then loaded into the cell and pressurized at 477.5 psi (3292 kPa) for 10 minutes. The torque plate is seated using the lever and held for two minutes. Eight additional minutes are then allowed to pass. The breaking torque is then measured in four breaks at 30 seconds apart:

- 36 inch pounds (41.47 kg-cm)
- 39 inch pounds (44.93 kg-cm)
- 40 inch pounds (46.08 kg-cm)
- 41 inch pounds (47.23 kgt-cm)

The drilling fluid sample has an average 0.039 Stuck Tendency Coefficient. The pressure is then removed and the cell is carefully opened, leaving the torque plate set in the filter cake. The torque plate and cake are washed and the torque plate is turned (not lifted) loose. The diameter of the imprint of the torque plate impression (smoothed dome area) is measured at 1.57" (3.95 cm) diameter, which gives a radius of 0.785" (1.98 cm).

Therefore, (using inch dimensions):

$$K_{sc} = (.001 \times 39.3) / (.785)^3 = 0.081$$

Theory

Worksheet

1. Using the spherical torque plate and inch dimensions:

$$K_{st} = \frac{(\text{Average Torque Wrench Reading}) \times (\text{Pressure}) \times (.001)}{477.5}$$
$$= \frac{(\quad) \times (\quad) \times (.001)}{477.5} =$$

For a standard pressure of 477.5 PSI (3,292 kPa):

$$K_{st} = (\text{Average Torque Wrench Reading}) \times .001$$
$$= (\quad) \times (.001) =$$

2. Using the spherical torque plate and 477.5 PSI (3,292 kPa) and inch dimensions:

- a. For cake with less than 1" stuck radius:

$$K_{sc} = \frac{(\text{Average Torque Wrench Reading}) \times (.001)}{(\text{Measured Stuck Cake Radius})^3}$$
$$= \frac{(\quad) \times (.001)}{(\quad)^3} =$$

- b. Using either the spherical or flat torque plate and 477.5 PSI (3,292 kPa) and inch dimensions:

For cake with 1" radius, edge effects considered and a pressure 477.5 PSI (3,292 kPa):

$$K_{sc} = \frac{(\text{Average Torque Wrench Reading}) \times (.001)}{1 + 1.33 (\text{Cake Height on Edges})}$$
$$= \frac{(\quad) \times (.001)}{(1 + 1.33 (\quad))} =$$

Maintenance

1. Disassemble the test cell after each test and thoroughly clean and dry all surfaces.
2. Check all o-rings and o-ring grooves for signs of wear or damage. Replace any damaged o-ring and lubricate all o-rings before they are installed.
3. Wash and dry the support screen and the locking mesh disk (If used).
4. Wipe any spilled fluid or other debris from the stand. Some materials may damage the finish of these parts if allowed to remain for a long period of time.
5. Sample fluids can cause corrosion in the test cell and cap. The standard cell is made of 303 stainless steel, however other materials, which are more corrosive resistant, are available. Periodically inspect the inside of the cell for evidence of corrosion. Light corrosion may be removed using 329 or finer wet or dry sand paper. Deeper corrosion pitting may be removed by sand blasting the area of the corrosion. If severe corrosion is evident, the cell should be replaced.
6. A metal-to-metal pressure tight seal is made between the valve stem and its seat. Leaks can occur if either the valve stem or the seat is damaged. The conical point of the valve stem should be inspected for damage by removing the stem from the cap or cell body and replacing the stem if the point is damaged. If the point is in good condition, the seat in the cell or cap may be rough. A $\frac{5}{16}$ " drill bit can be used to re-surface the seat, or a special resurfacing tool may be ordered from OFI Testing Equipment. Valve stems should also be inspected for possible plugging of the passages by dried fluid samples. A small drill or wire may be used to insure that both the cross-bore and the main passage openings are clear.

Diagrams

Full Unit

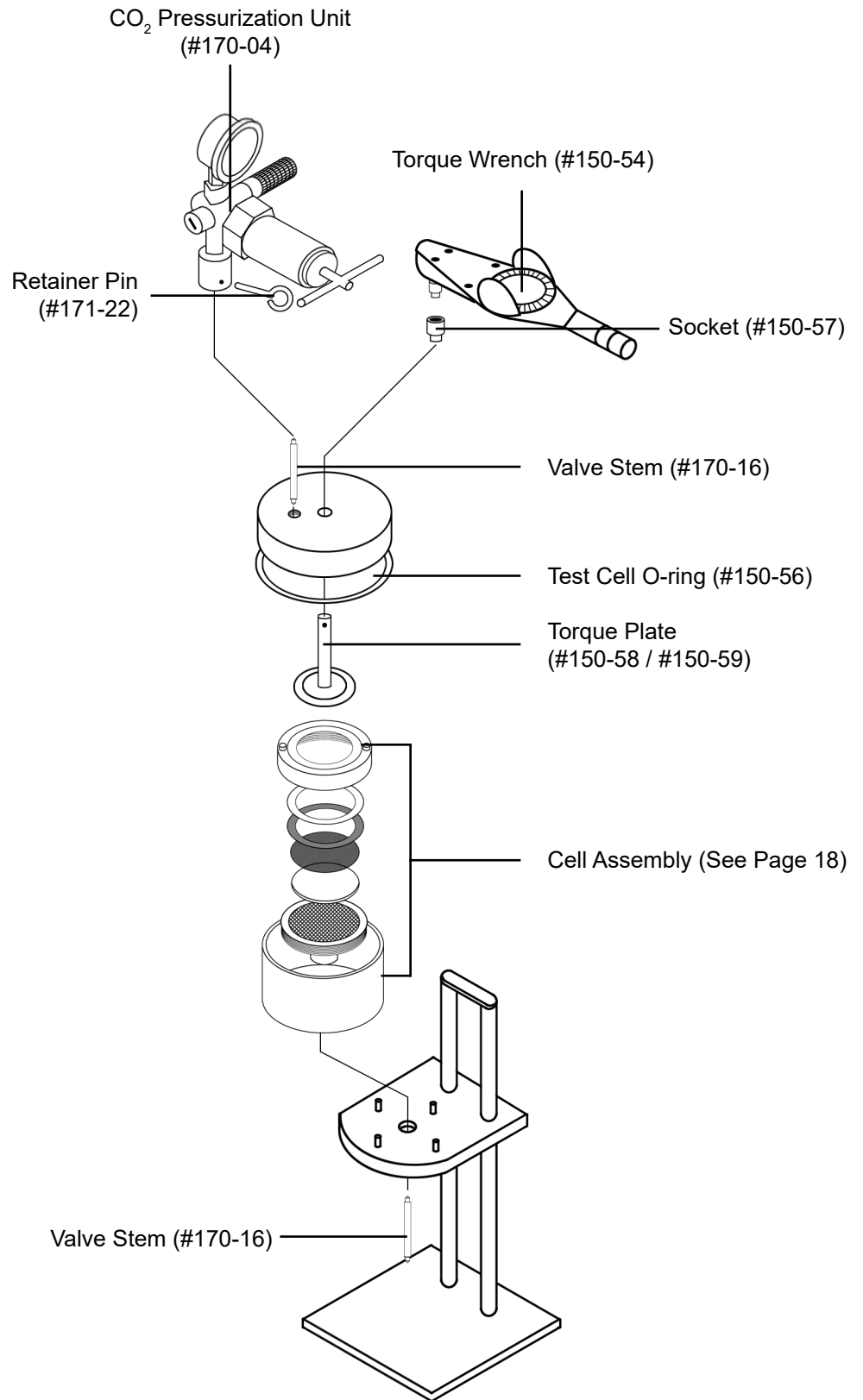

Diagrams

Cell Assembly

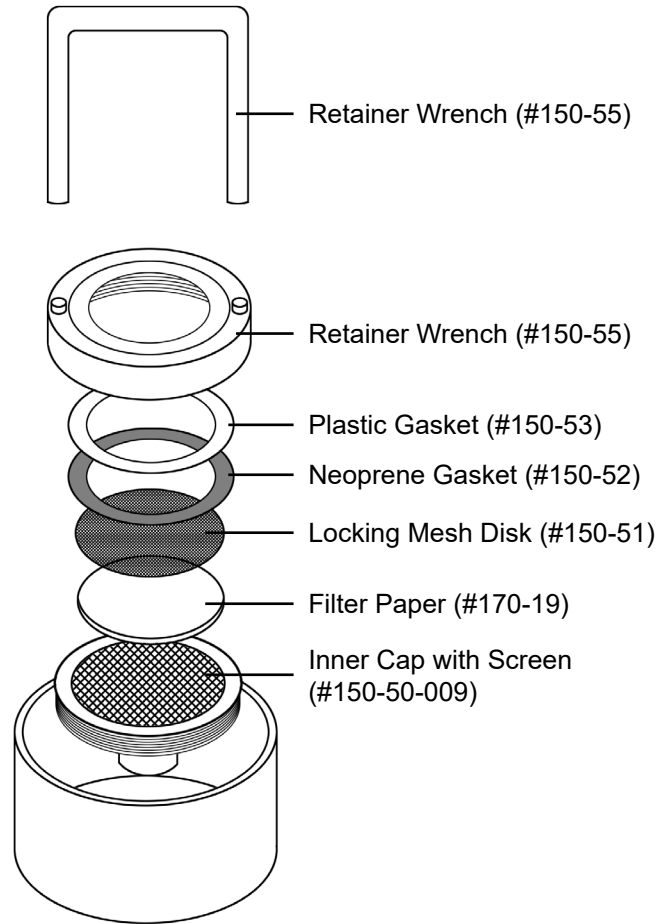

Warranty and Return Policy

Warranty:

OFI Testing Equipment, Inc. (OFITE) warrants that the products shall be free from liens and defects in title, and shall conform in all respects to the terms of the sales order and the specifications applicable to the products. All products shall be furnished subject to OFITE's standard manufacturing variations and practices. Unless the warranty period is otherwise extended in writing, the following warranty shall apply: if, at any time prior to twelve (12) months from the date of invoice, the products, or any part thereof, do not conform to these warranties or to the specifications applicable thereto, and OFITE is so notified in writing upon discovery, OFITE shall promptly repair or replace the defective products. Notwithstanding the foregoing, OFITE's warranty obligations shall not extend to any use by the buyer of the products in conditions more severe than OFITE's recommendations, nor to any defects which were visually observable by the buyer but which are not promptly brought to OFITE's attention.

In the event that the buyer has purchased installation and commissioning services on applicable products, the above warranty shall extend for an additional period of twelve (12) months from the date of the original warranty expiration for such products.

In the event that OFITE is requested to provide customized research and development for the buyer, OFITE shall use its best efforts but makes no guarantees to the buyer that any products will be provided.

OFITE makes no other warranties or guarantees to the buyer, either express or implied, and the warranties provided in this clause shall be exclusive of any other warranties including ANY IMPLIED OR STATUTORY WARRANTIES OF FITNESS FOR PURPOSE, MERCHANTABILITY, AND OTHER STATUTORY REMEDIES WHICH ARE WAIVED.

This limited warranty does not cover any losses or damages that occur as a result of:

- Improper installation or maintenance of the products
- Misuse
- Neglect
- Adjustment by non-authorized sources
- Improper environment
- Excessive or inadequate heating or air conditioning or electrical power failures, surges, or other irregularities
- Equipment, products, or material not manufactured by OFITE
- Firmware or hardware that have been modified or altered by a third party
- Consumable parts (bearings, accessories, etc.)

Returns and Repairs:

Items being returned must be carefully packaged to prevent damage in shipment and insured against possible damage or loss. OFITE will not be responsible for equipment damaged due to insufficient packaging.

Any non-defective items returned to OFITE within ninety (90) days of invoice are subject to a 15% restocking fee. Items returned must be received by OFITE in original condition for it to be accepted. Reagents and special order items will not be accepted for return or refund.

OFITE employs experienced personnel to service and repair equipment manufactured by us, as well as other companies. To help expedite the repair process, please include a repair form with all equipment sent to OFITE for repair. Be sure to include your name, company name, phone number, email address, detailed description of work to be done, purchase order number, and a shipping address for returning the equipment. All repairs performed as "repair as needed" are subject to the ninety (90) day limited warranty. All "Certified Repairs" are subject to the twelve (12) month limited warranty.

Returns and potential warranty repairs require a Return Material Authorization (RMA) number. An RMA form is available from your sales or service representative.

Please ship all equipment (with the RMA number for returns or warranty repairs) to the following address:

OFI Testing Equipment, Inc.
Attn: Repair Department
11302 Steeplecrest Dr.
Houston, TX 77065
USA

OFITE also offers competitive service contracts for repairing and/or maintaining your lab equipment, including equipment from other manufacturers. For more information about our technical support and repair services, please contact techservice@ofite.com.