



Dependable Products From People You Trust



Model 4005 Automated UCA-SGSM

Patent No. 9,612,232 - OFI Testing Equipment, Inc.

#120-56 - UCA Only

#120-56-C - UCA with SGSM

Instruction Manual

Updated 1/17/2023

Ver. 2

OFI Testing Equipment, Inc.

11302 Steeplecrest Dr. · Houston, Texas · 77065 · U.S.A.

Tele: 832.320.7300 · Fax: 713.880.9886 · www.ofite.com

©Copyright OFITE 2018

Table of Contents

Introduction	3
Description	3
Features	3
Specifications	4
Requirements	4
Components	4
Safety	5
Quick Start	6
UCA.....	6
SGSM	7
Setup	8
Software	11
General Setup.....	11
UCA Setup	12
SGSM Setup	14
Profile Builder.....	18
Main Screen.....	20
Events	22
Calculated Values	23
Onboard Display	24
Real-Time Data.....	25
Test Setup - Test Config.....	26
Test Setup - Profile.....	27
Calibrate.....	28
Utilities.....	29
Archive	30
Manual Control.....	31
Start Test.....	32
UCA	33
Cell Assembly	33
Connecting the Cell.....	36
Starting the Test.....	37

<i>Stopping the Test</i>	38
<i>Disassembling and Cleaning the Test Cell</i>	39
SGSM	40
<i>Cell Assembly</i>	40
<i>Drag Check</i>	46
<i>Preparing the Test Cell</i>	47
<i>Connecting the Test Cell</i>	48
<i>Starting the Test</i>	49
<i>Stopping the Test</i>	50
<i>Evaluating Test Data</i>	51
<i>Disassembling and Cleaning the Test Cell</i>	52
Maintenance	58
<i>Maintenance Schedule</i>	58
<i>Fuses</i>	59
<i>Rupture Disk</i>	60
<i>Filters</i>	61
<i>Troubleshooting</i>	63
Calibration	67
<i>Pressure Transducer</i>	67
<i>Thermocouple</i>	68
<i>UCA Ultrasonic Transducer</i>	69
<i>SGSM Load Cell</i>	71
Appendix	73
<i>Electrical System Grounding</i>	73
<i>UCA Cell Assembly Diagram</i>	74
<i>SGSM Cell Assembly Diagram</i>	75
<i>SGSM Drive Assembly Diagram</i>	76
Warranty and Return Policy	77

Introduction

By measuring the change in velocity of an acoustic signal, the Ultrasonic Cement Analyzer provides a continuous non-destructive method of determining compressive strength as a function of time.

Description

The cement slurry to be tested is placed in heating jacket with temperature and pressure adjusted to simulate downhole conditions. An acoustic signal is then transmitted through the cement sample. As the strength of the cement increases over time, the acoustic signal travels faster through the sample.

A computer running customized Windows® software measures the transit times of the signal over time and interpolates the compressive strength values. This data is available in real time on-screen and is also stored in an Excel® spreadsheet for easy graphical viewing and printing.

The Twin Cell UCA features two test cells in a single enclosure. Both units share electrical power; air, water, and drain plumbing; and PC to UCA connectivity. All other systems (heating, pressurization, etc.) are completely separate.

Features

- Cement samples are not destroyed
- Programmable temperature control (up to 400°F or 204.4°C)
- Self-venting regulators provide extensive pressure control (up to 5,000 psi or 34.5 MPa)
- Data is available instantly on screen and is automatically converted to Excel® spreadsheet format

Specifications

- **Maximum Pressure:** 5,000 psi (34.5 MPa)
- **Maximum Temperature:** 400°F (204.4°C)
- **Size:** 26" × 21" × 13" (66 × 53 × 33 cm)
- **Weight:** Approximately 70 lb (31.8 kg)

Requirements

- **Air Supply:** 100 psi (690 kPa) Recommended, 150 psi (1,035 kPa) Maximum, ¼" NPT Connector
- **Water Supply:** 40–100 psi, 40°–100°F, ¼" NPT Connector
- **Water Drain:** ¼" NPT Connector (suitable for high temperatures)
- **Coolant Supply:** ¼" NPT Connector
- **Coolant Drain:** ¼" NPT Connector (suitable for high temperatures)
- **Power Supply:**
 - **Electronics:** 230–240 Volt, 50–60 Hz, 5 Amp, Fuse: T5A, 250 Volt
 - **Heaters:** 230–240 Volt, 50–60 Hz, 8 Amp, Fuse: T8A, 250 Volt
- **Computer:**
 - Windows XP or higher
 - Minimum Screen Resolution: 1,280 × 680
- **Environmental Conditions:**
 - For indoor use only
 - Maximum Altitude: 2,000 m (6,562 ft)
 - Temperature: 5°–40°C (41°–104°F)
 - Maximum Relative Humidity: 80% for temperatures up to 88°F (31°C) decreasing linearly to 50% at 104°F (40°C)

Components







Only use replacement parts that have been supplied by OFITE.

#120-50-TR	Ultrasonic Transducer, Set of 2
#120-50-063	Set of Transducer Cables
#120-50-1	Cell Body
#120-51-2	Cell Cap, Bottom
#120-51-3	Cell Cap, Top, For UCA Tests
#120-51-021	Fill Gauge
#123-011	O-ring for Test Cell, Viton
#123-024-1	Acoustic Couplant, 12 oz

Optional:

#120-56-SP	Spare Parts Kit
#120-56-505	Heater, 1200 Watt, Qty: 2
#120-51-020-2	Thermocouple, Type J, Qty: 2
#122-073-1	Fuse, 3 Amp, 5 m × 20 m, Qty: 12
#123-011	O-ring for Cell, Viton 90D, Qty: 120
#123-024-1	High-Temperature Ultrasonic Couplant, 12 oz

Safety

Explanation of Symbols	
	Caution: Risk of Danger - This symbol directs the operator to consult the instruction manual for safety related warnings. (ISO-7000-0434) Whenever this symbol is used on the equipment, the user must consult the manual to determine the nature of the hazard and any actions which have to be taken.
	Hot: This symbol indicates that a surface may be hot to the touch.
	Shock Hazard: This symbol indicates a risk of electrical shock.
 Note	Note: This symbol will indicate important notes and helpful hints for the operation of the equipment.
 Tip	Tip: This symbol is used to identify operational information and best practices to obtain the most reliable data.
	Caution: Note - This symbol is used to indicate statements in the manual which warn against actions which may cause damage to the equipment during routine service or maintenance.

Quick Start

UCA

1. Set up the test in the software (page 12) or in the onboard display (page 24).
2. Create a Test Profile in the software (page 18) or in the onboard display (page 25).
3. Mix the cement slurry.
4. Assemble the test cell (page 30), fill the cell with cement, load it into the heating jacket, and make all the necessary connections (page 33).
5. Turn the Water Supply valve to “FILL” and wait for water to come out of the thermocouple port.
6. When the cell is full, turn the tighten the thermocouple and turn the Water Supply valve to “OPERATE”.
7. Set the “HEAT”, “COOL”, and “PRESSURE” switches to “AUTO”.
8. Click or touch the “Start Test” button.
9. After the test, allow test cell to cool down and remove it from the heating jacket (page 38).
10. Disassemble the test cell and remove the hardened cement (page 39).
11. Clean and inspect all of the test cell components.

Quick Start

SGSM

1. Set up the test in the software (page 14) or in the onboard display (page 26).
2. Create a Test Profile in the software (page 18) or in the onboard display (page 27).
3. Assemble the test cell (page 40) and run a Drag Check (page 46).
4. Mix the cement slurry.
5. Fill the cell with cement and load it into the heating jacket.
6. Connect the Water Fill Tube to the inlet port on the top of the cell. Connect the thermocouple to the thermocouple port on the cabinet (page 48).
7. Turn the Water Supply valve to “FILL” and wait for water to come out of the weep hole on the SGSM magnet cover.
8. When the cell is full, tighten the weep hole and turn the Water Supply valve to “OPERATE”.
9. Set the “HEAT”, “COOL”, and “PRESSURE” switches to “AUTO”.
10. Click the “Start Test” button in the software or touch the “Start Test” button on the display.
11. After the test, allow test cell to cool down before removing it (page 50).
12. Disassemble the test cell and clean the cement from the test cell and all other components (page 52).
13. Clean and inspect all of the test cell components for damage or wear.

Setup



1. Carefully remove the instrument from the crate and place it on a flat, stable surface. Make sure to allow for adequate air flow around the unit, especially near the vents on the sides and back.

To ensure personal safety, always use proper lifting techniques.

Position the unit such that the user can quickly disconnect all electrical plugs in case of an emergency.

2. Make sure all switches are off and the valves on the front are turned to DRAIN.
3. Connect the **AIR, CHILL IN, CHILL OUT, WATER SUPPLY, and DRAIN** connectors on the back of the unit to their appropriate source and plug in the power cords.



Make sure the “Drain” and “Chill Out” are suitable for high temperature discharge.



Make sure the compressed air supply is clean and dry.

4. Connect the UCA to the PC. The UCA can connect to the PC via serial (RS-232), Ethernet, or USB.

Do not connect an Internet device (PC, laptop, wall-mounted Ethernet port, etc.) to the SGSM port. This could damage your devices.



5. If you will be running an SGSM test, connect the SGSM head to the corresponding port on the back of the UCA with the supplied Ethernet cable. The cell on the left is SGSM 1 and the cell on the right is SGSM 2.

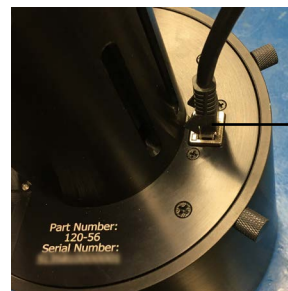

Ethernet Cable

6. Make sure the HEAT, COOL, and PRESSURE switches are all in the OFF position before turning on the main power.
7. Turn the “Main Power” switch on.
8. Open the software and connect using the device manager (page 11). Ensure that the live data on the front panel displays matches the data displayed on the software.

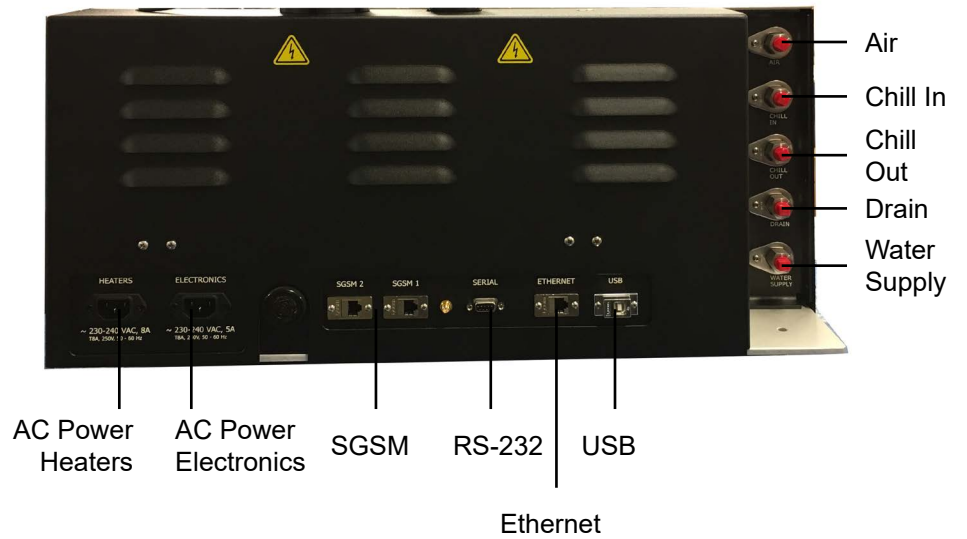
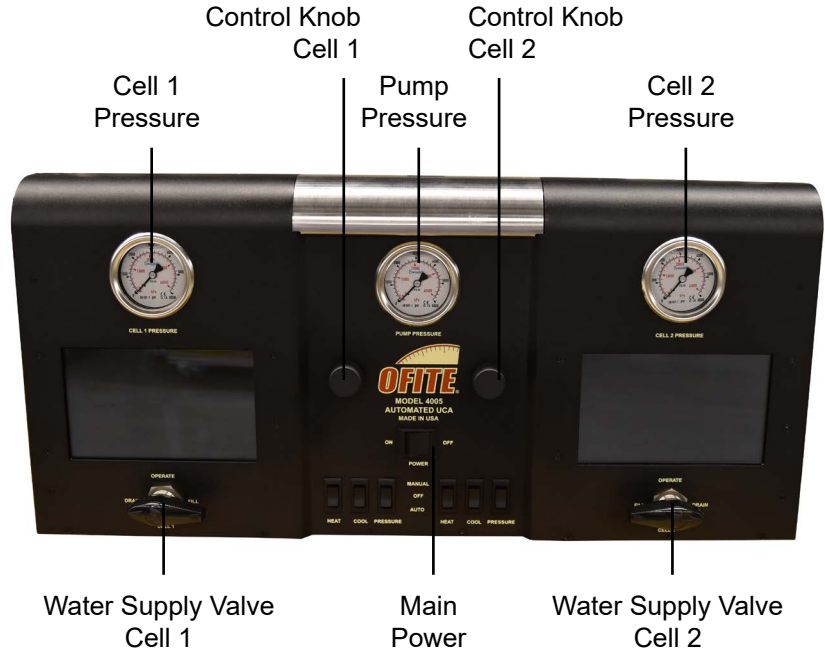



Control Knob

Control Panel

Power - Main power switch

Heat

Manual - Cell temperature is controlled through the Onboard Display (page 31)

Off - Heaters are disengaged

Auto - Cell temperature is controlled by the Test Profile. (See page 18 for building a Test Profile in the software or page 27 for the Onboard Display.)

Cool

Manual - Cooling fluid is circulating to cool the cell

Off - Cooling fluid is not circulating.

Auto - Cooling fluid circulation is controlled by the test.

Pressure

Manual - Pressure is controlled through the Onboard Display (page 31)

Off - The pump is not engaged

Auto - Cell pressure is controlled by the Test Profile. (See page 18 for building a Test Profile in the software or page 27 for the Onboard Display.)

Onboard Display Control Knob - Controls the cursor on the Onboard Display. Turn the knob to move the cursor around the screen. Push the knob in to select an option or parameter.

Software

General Setup



1. Open the software.

The software must be run with Administrator privileges. There are two ways to do this:

- a. Right-click the icon and select “Run as Administrator”.
 - b. Right-click the icon and select “Properties”. On the Compatibility tab, check the box next to “Run this program as an administrator” and click OK.
2. When the Manage Devices screen appears, right-click the device from the list and select “Set as Default”. Then click “Done”.

Make sure to enable the appropriate communication method for your device. If you have connected the UCA to the PC via USB, select “Enable USB Comms”, etc.

Depending on the connection types you enable, your device might show up multiple times or other OFITE equipment might appear on the list. Make sure you select the correct device and connection type you wish to use.

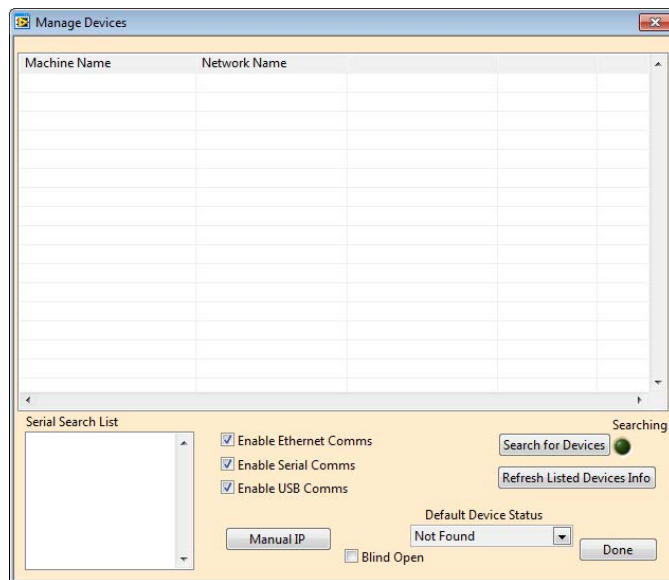

3. Choose “Options” from the “Edit” menu on the main software screen.
4. Select a folder to save all test data and click “OK”.

Software

UCA Setup

1. Select Edit → Cell 1 (or Cell 2) → Test
2. On the Information tab, enter the necessary information.

The Cement Density field is used to calculate the compressive strength during UCA tests. All other fields on this tab are optional.

The Bob Height and Bob Diameter fields are only used in SGSM tests. For UCA tests, they can be ignored.

The screenshot shows a software window titled 'Test' with four tabs: 'Information', 'Configuration', 'Profile', and 'Cell 1'. The 'Information' tab is active, displaying a 'Test Information' form. The form includes the following fields and controls:

- Test Name: Text input field
- Test ID: Text input field
- Customer: Text input field
- Lab Technician: Text input field
- Cement Manufacturer: Text input field
- Cement Density: Text input field with '0' and 'lb/gal' label
- Job Type: Dropdown menu with 'Production' selected
- Rig Name: Text input field
- Well Name: Text input field
- Pad Name: Text input field
- Cement Class: Text input field
- BHCT: Text input field with '0' and 'mm' label
- BHST: Text input field with '0' and 'mm' label
- Bob Height: Text input field with '0.041275' and 'mm' label
- Bob Diameter: Text input field with '0.0508' and 'mm' label
- Additives: Text input field
- Comments: Text input field

At the bottom right of the window, there are 'Save' and 'Cancel' buttons.

3. On the Configuration tab, set the following parameters:

Type: Select UCA

Stop at End: When this option is “No”, the test will run until you click the “Stop Test” button. The final temperature and pressure setpoints will be maintained indefinitely. If this option is “Yes”, the test will end when all steps in the Test Profile are complete.

Temp Unit: Choose either F (Fahrenheit) or C (Celsius)

CS Unit: Choose units for compressive strength (psi or MPa)

Density Unit: Choose either lb/gal or kg/cu m

Temperature Control: The instrument has two thermocouples. One is in the cement sample in the cell. The other is in the heating jacket (Bath). Use this option to determine which thermocouple will be used to control the temperature. The “Sample” setting is recommended during testing. The “Bath” setting is recommended during pre-heat.

DAQ Rate: Set the interval for data points to be recorded (hh:mm:ss).

Press Unit: Choose units for cell pressure (psi or MPa).

TT Algorithm: Choose an algorithm for calculating compressive strength based on the density of the sample. Choosing “Auto” allows the software to pick the best algorithm depending on the cement density entered on the Information tab.

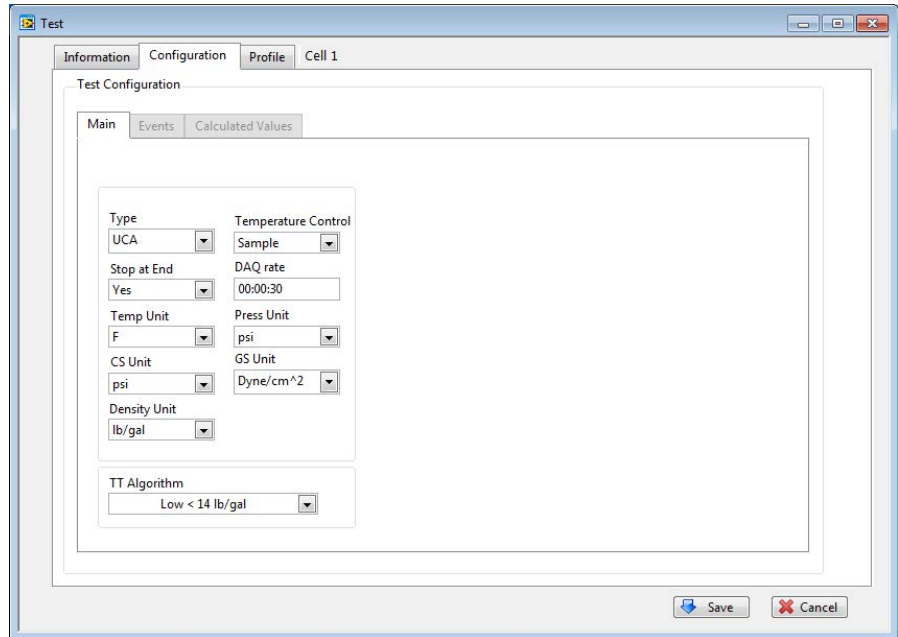

4. On the Profile tab, select a Test Profile from the list. To create a new Test Profile, click the “Open Builder” button (page 18).

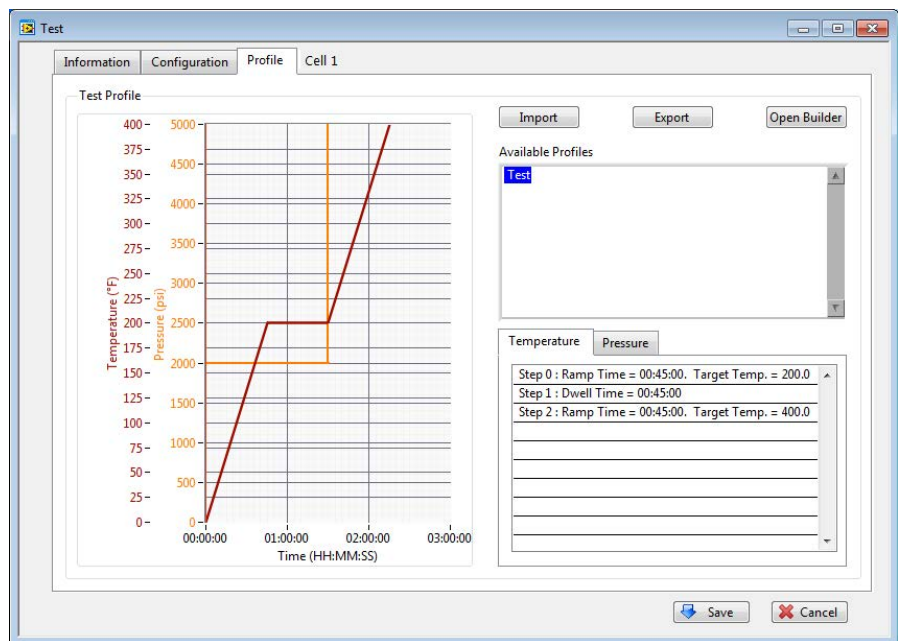

5. Click “Save”

Software

SGSM Setup

1. Select Edit → Cell 1 (or Cell 2) → Test
2. On the Information tab, enter the necessary information.

The Bob Height and Bob Diameter fields are used to calculate the gel strength during SGSM tests. All other fields on this tab are optional.

The screenshot shows a software window titled "Test" with four tabs: "Information", "Configuration", "Profile", and "Cell 1". The "Information" tab is active, displaying a form for "Test Information". The form includes the following fields:

- Test Name
- Test ID
- Customer
- Lab Technician
- Cement Manufacturer
- Cement Density (0 lb/gal)
- Job Type (Production)
- Blend
- Additives
- Comments
- Rig Name
- Well Name
- Pad Name
- Cement Class
- BHCT (0)
- BHST (0)
- Bob Height (0.041275 mm)
- Bob Diameter (0.0508 mm)

At the bottom right of the window, there are "Save" and "Cancel" buttons.

3. On the Configuration tab, set the following parameters:

Type: Select SGSM

Stop at End: When this option is “No”, the test will run until you click the “Stop Test” button or the gel strength reaches the value in the Final Strength field. The final temperature and pressure setpoints will be maintained indefinitely. If this option is “Yes”, the test will end when all steps in the Test Profile are complete.

Temp Unit: Choose either F (Fahrenheit) or C (Celsius)

Density Unit: Choose either lb/gal or kg/cu m

Temperature Control: The instrument has two thermocouples. One is in the cement sample in the cell. The other is in the heating jacket (Bath). Use this option to determine which thermocouple will be used to control the temperature. The “Sample” setting is recommended during testing. The “Bath” setting is recommended during pre-heat.

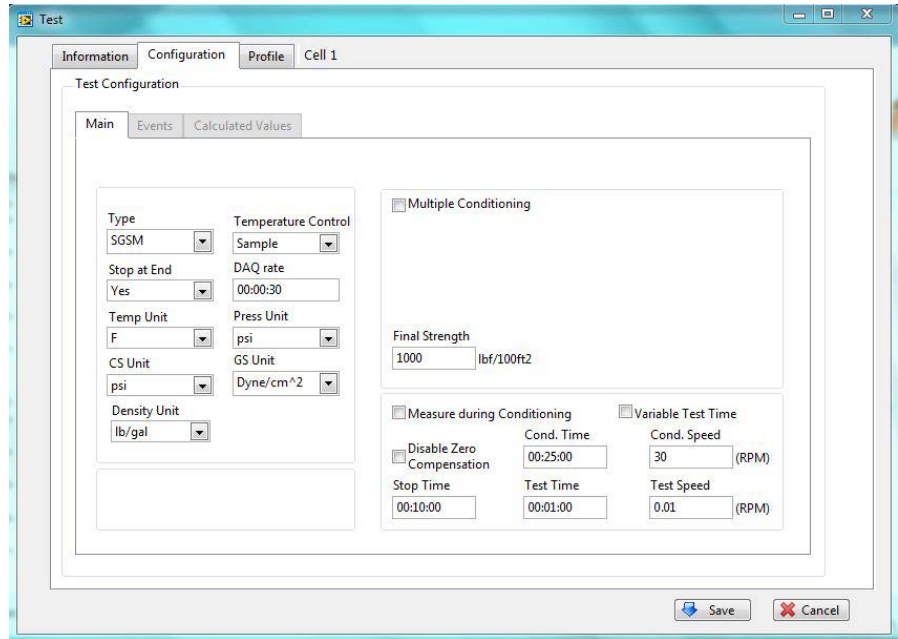

DAQ Rate: This field is not editable for SGSM tests.

Press Unit: Choose units for cell pressure (psi or MPa).

GS Unit: Choose units for gel strength (lb/100 ft² or Dyne/cm²)

Multiple Conditioning: When this option is unchecked, the SGSM will condition the sample only once, at the beginning of the test. When this option is checked, the SGSM will condition the sample every time the gel strength exceeds the value in the Threshold Strength field but does not exceed the Final Strength.

Disable Multizero: When this option is unchecked, the software will perform the zero function after every conditioning cycle. When this option is checked, the software will perform the zero function only once, after the first conditioning. This option is off by default.

Threshold Strength: When the peak gel strength meets or exceeds this value and Multiple Conditioning is turned on, the software will trigger a conditioning cycle.

Final Strength: When the peak gel strength meets or exceeds this value, the test will end.

Conditioning Cycles: When Multiple Conditioning is on and the peak gel strength meets or exceeds the value in the Threshold Strength field, the software will advance to the next Conditioning Cycle and condition the sample for the set time at the set speed. Cycle 0 is the initial conditioning, before any measurements are taken. Click the Edit Cycles button to add Conditioning Cycles.

Multiple Conditioning Conditioning Cycles
Disable Multizero
Repeat Cycles
Threshold Strength
0 lbf/100ft2
Final Strength
1000 lbf/100ft2
Cycle 0 : Time = 00:00:30. Speed = 60
Cycle 1 : Time = 00:00:30. Speed = 60
Cycle 2 : Time = 00:00:30. Speed = 60

Measure During Conditioning: When this option is unchecked, the SGSM will condition the cement in the opposite direction from measurement. This reduces the load on the transducer to prolong its life. When this option is checked, the SGSM will condition in the same direction as measurement and will record data during the conditioning cycle.

Enabling this option is not recommended. It will shorten the life of the ultrasonic transducers.

Variable Test Time: When this option is checked, the SGSM will end the measurement period immediately when it senses a gel strength peak. When this option is unchecked, the SGSM will continue the measurement period for the entire “Test Time”, regardless of when the gel strength peak was detected.

Disable Zero Compensation: The Zero Compensation routine measures and maps the mechanical resistance in the bushings in order to compensate and give better readings. When this option is checked, the Zero Compensation routine will be skipped.

Stop Time: The amount of time the bob will pause between gel strength measurement periods.

Cond. Time: The amount of time the SGSM will condition the cement before it begins measuring gel strength. This field is disabled if Multiple Conditioning is turned on.

Cond. Speed: The speed (rpm) the bob will turn during conditioning. This field is disabled if Multiple Conditioning is turned on.



Note

Test Time: The amount of time the bob will turn while measuring gel strength.

Test Speed: The speed (rpm) the bob will turn to measure the gel strength of the cement.

Variable Test Time: The bob will turn until the software detects a peak gel strength. When the gel starts to break, the bob will stop turning.

4. On the Profile tab, select a Test Profile from the list. To create a new Test Profile, click the “Open Builder” button (page 18).
5. Click “Save”

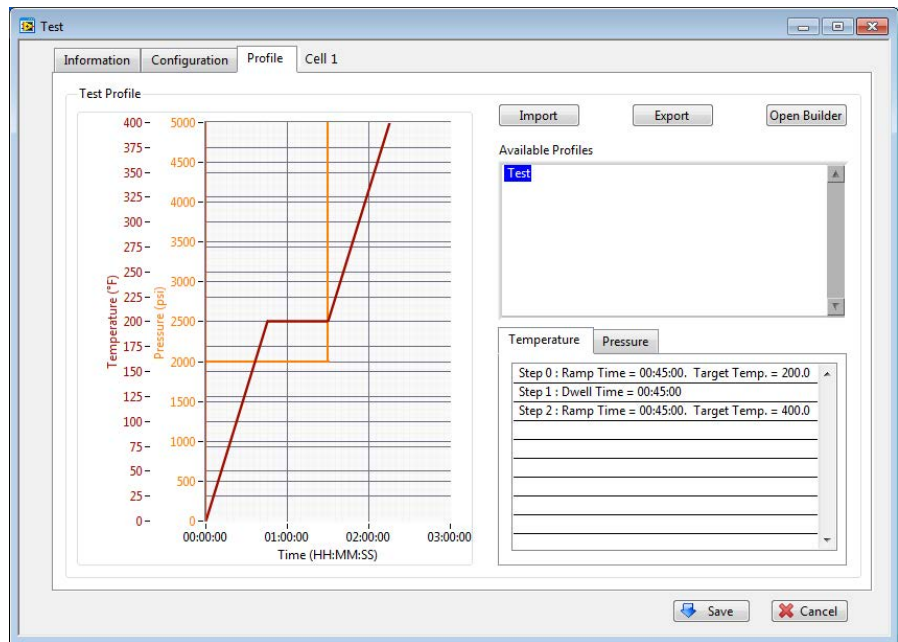

Software

Profile Builder

The Test Profile Builder creates temperature and pressure profiles for both the UCA and SGSM tests.

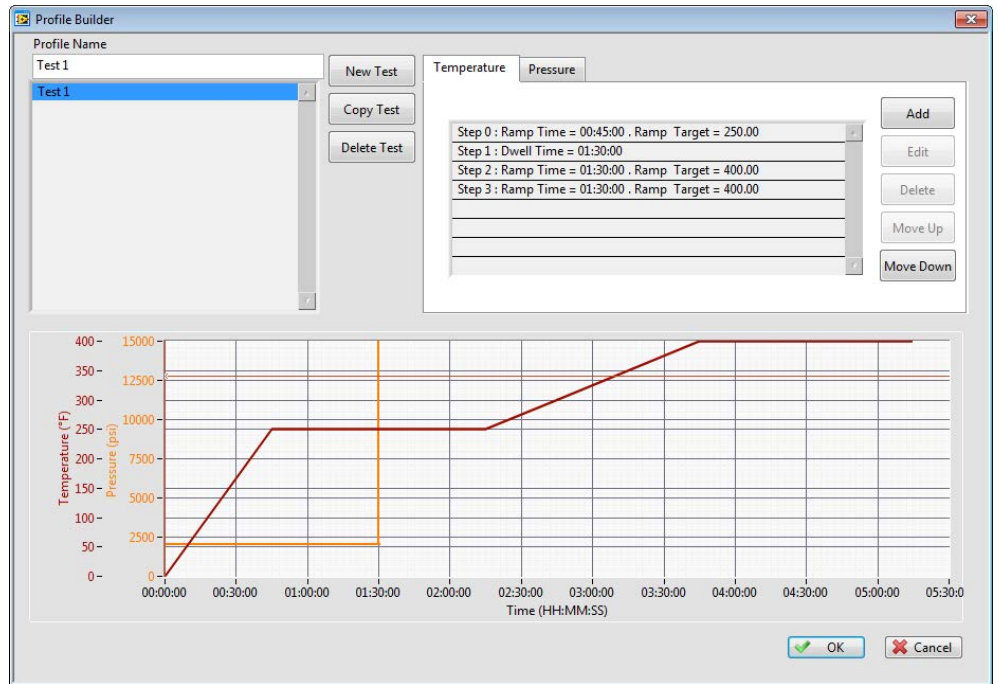

1. Select Edit → Cell 1 (or Cell 2) → Test. On the Profile tab, click the “Open Builder” button.
2. Click "New Test" to build a new test profile. To edit a current test profile, select a test from the list on the left-hand side by double clicking on the appropriate test
3. In the "Profile Name" box, enter a test name.
4. Each test profile has two parameters: temperature and pressure. For each parameter, there is a series of steps. Each step specifies the setpoint and other options for that parameter.

To add a step, click the Temperature or Pressure tab and then click the “Add” button. As you add steps to the test profile, the graph below will change to reflect the new data.



Important

When building a test at temperatures above 190°F (87.8°C), the unit will calculate and apply a minimum pressure to prevent the sample from boiling. A pressure of 1,000 psi (6.9 MPa) is also required to get a good transit time signal during UCA tests.

There are three types of steps:

- Ramp – This will increase the temperature or pressure up to the target in a set number of minutes. You will be prompted for the ramp time (hh:mm:ss) and target.
- Step – This will increase the temperature or pressure up to the target as fast as possible. Enter the target in the "Target" box.
- Dwell – This will hold the current temperature or pressure for a set number of minutes. Enter the time (hh:mm:ss) into the "Time" Box.



Note

The maximum temperature setpoint allowed is 400°F (204.4°C). The unit allows pressure setpoints between 100 psi (689.5 kPa) and 5,000 psi (34.5 MPa). The units of measure will be the same as entered in the Setup menu. (See page 12 for setting UCA units and page 14 for setting SGSM units.)

Setup

Step Type Ramp

Time (min) 00:00:00

Target 0

OK

Cancel

5. To edit an existing step, double click the step in the step list or highlight the existing step and select the "Edit" button. Click OK when done.
6. Click the "OK" button to exit the "Setup" screen. The new Temperature Profile will now appear in the "Available Profiles" list on the "Profile" tab.

Software

Main Screen

The software has a set of four tabs. Each tab shows different information.

The **Info** tab shows the test information for each cell.

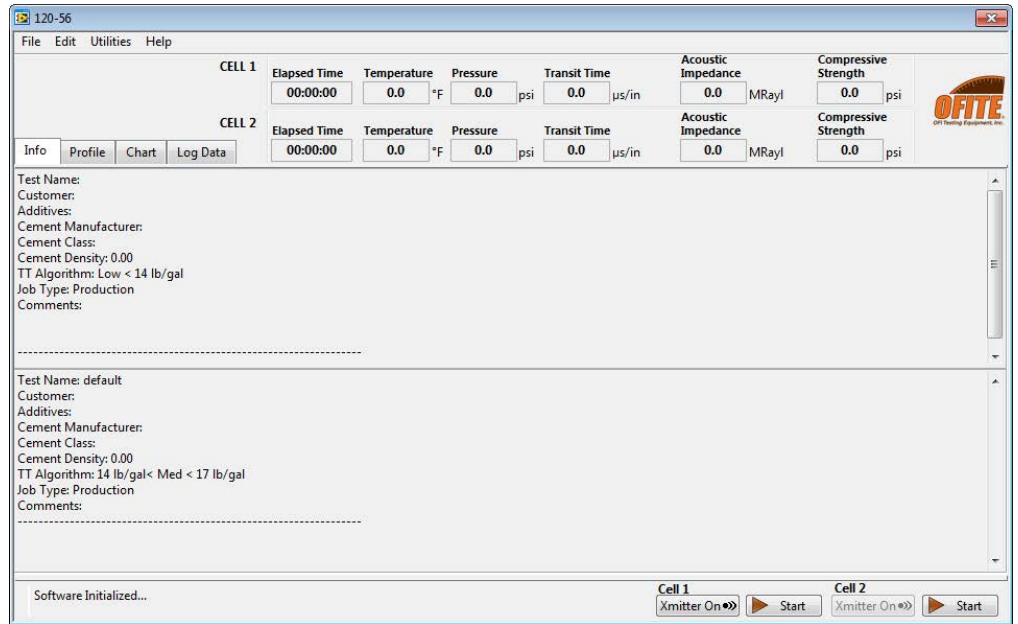

The **Profile** tab shows a graph of the Test Profile for each cell.

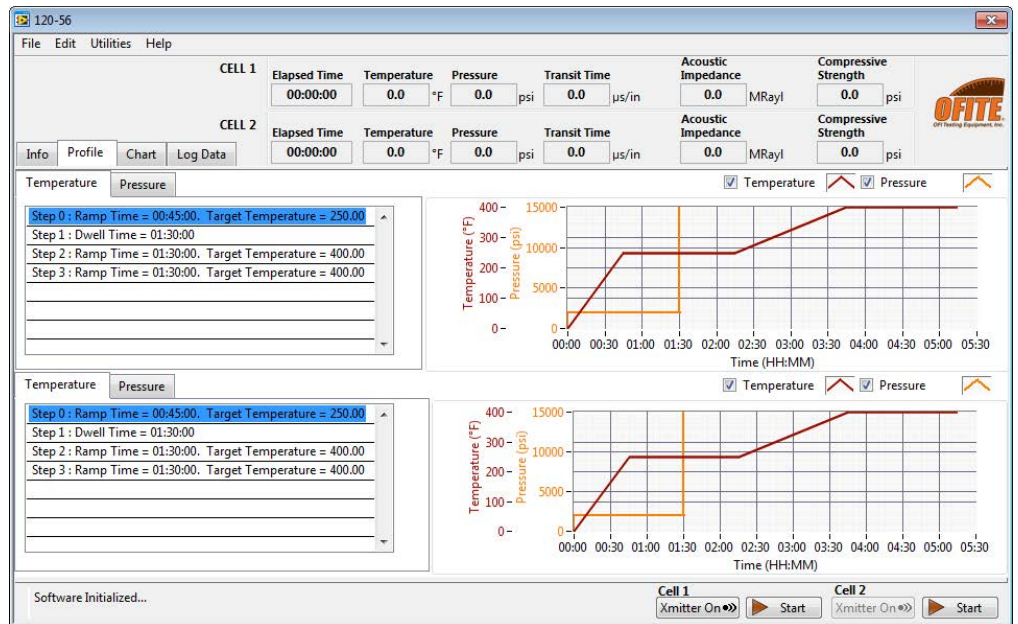

The **Chart** tab shows a graph of the current test conditions in each cell.

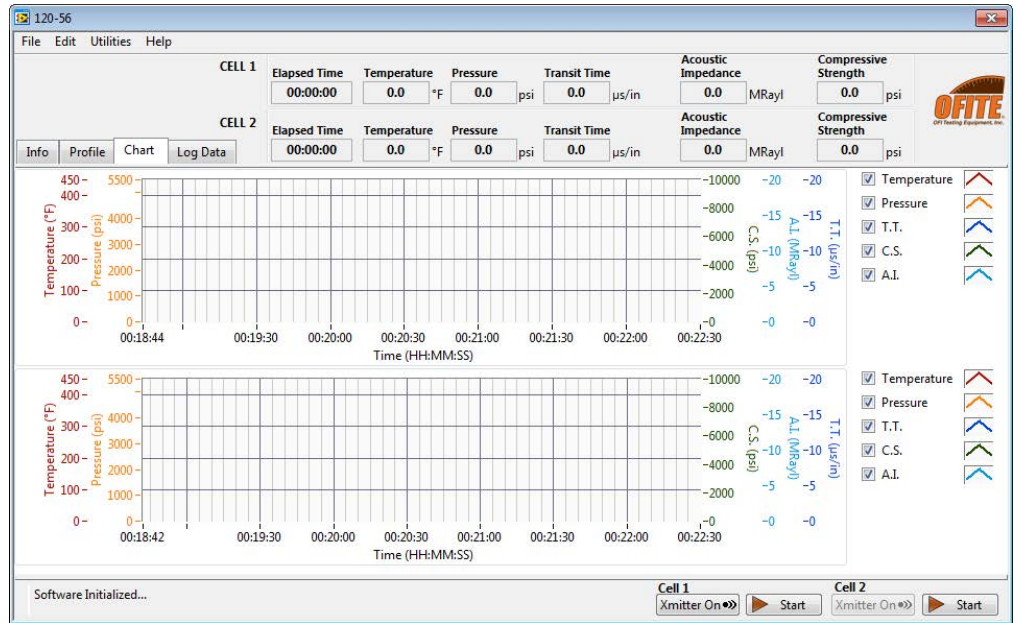

The **Log Data** tab shows the data for the current test in each cell.

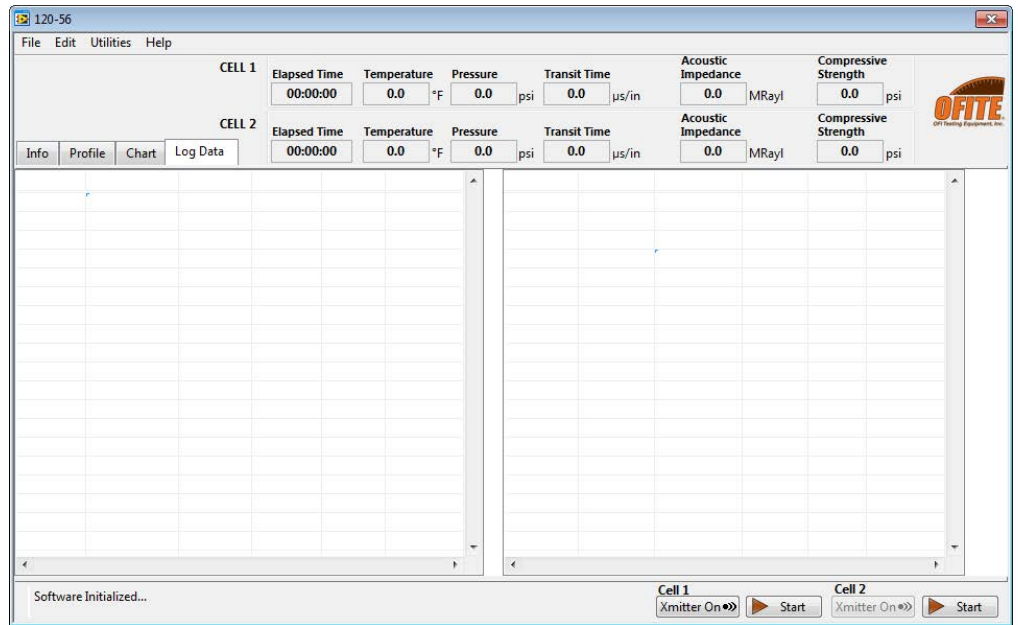

Software

Events

Events are triggered based on conditions in the test. When an Event is triggered, it can send an alert, end the test, or both.

To manage Events, choose Test from the Edit menu. Then go to the Configuration tab and then the Events tab.

1. Choose a Signal: Time, Temperature, Pressure, BC, Compressive Strength, Gel Strength, Transition Time, Expansion.
2. Enter the Value you want to test for. For example, if your Signal is Temperature, then a Value of 100 represents 100°.
3. Enter the time (in seconds) you want the Signal to be at the specified Value before triggering the event.
4. Choose a Condition.
5. If you want to be alerted when the conditions are met, select Enable under Alert.
6. If you want the test to end when the conditions are met, select Enable under End Test.
7. Click the Add button to add the Event.
8. To modify an Alert, select it in the list, make your changes, and then click the Update button.
9. Click Save.

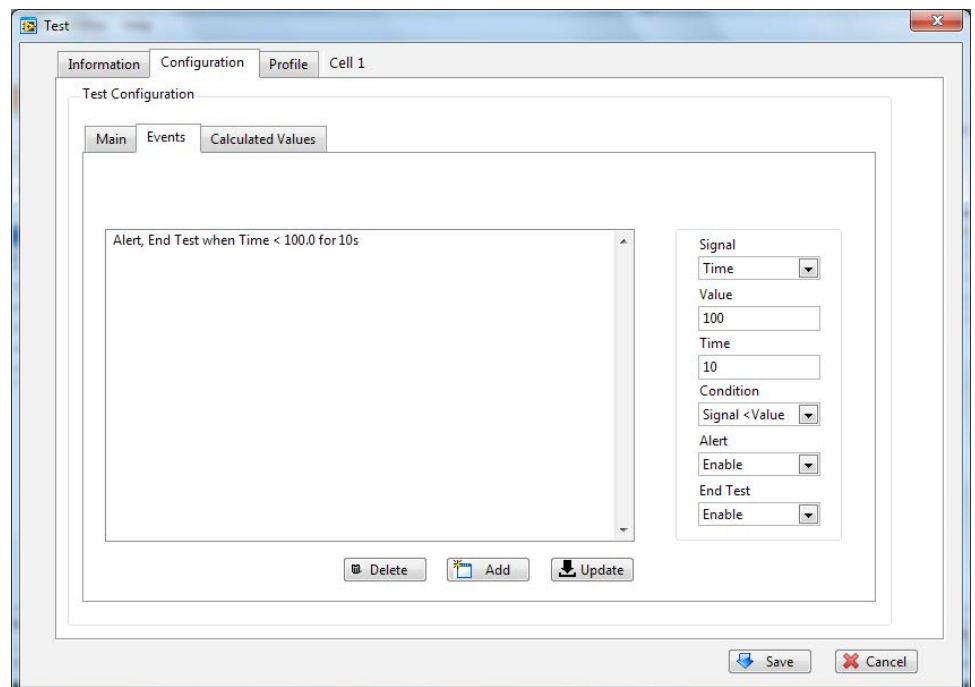

Software

Calculated Values

Calculated Values are triggered by conditions in the test. They are printed on the chart at the end of the test.

To manage Calculated Values, choose Test from the Edit menu. Then go to the Configuration tab and then the Calculated Values tab.

1. Choose a Signal: Time, Temperature, Pressure, BC, Compressive Strength, Gel Strength, Transition Time, Expansion.
2. Choose a Calculation:
 - **At Time:** Calculate the value of the Signal at a specific test time
 - **Time When:** Calculate the time when the Signal reaches a specified value
 - **Signal Min:** Calculate the minimum Signal value for the test
 - **Signal Max:** Calculate the maximum Signal value for the test
 - **Transition Time:** Calculate the time it takes the Signal to change from one value to another
3. Fill in the remaining fields. These fields will change depending on which Calculation you choose.
4. Click the Add button to add the Calculated Value.
5. To modify a Calculated Value, select it in the list, make your changes, and then click the Update button.
6. Click Save.

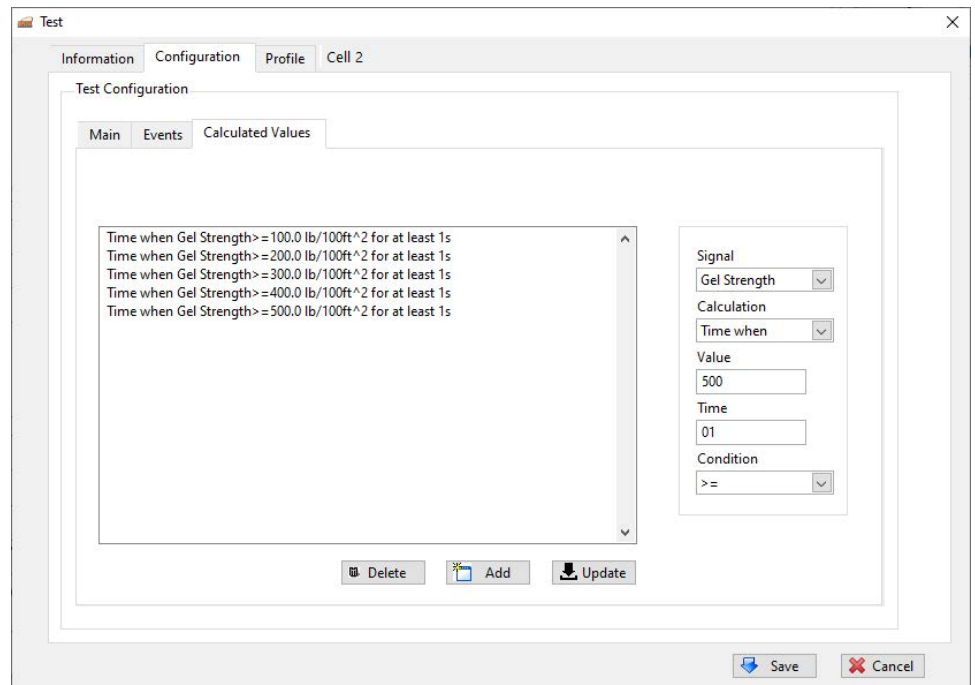

Onboard Display

The Model 4005 features two onboard displays, one for each cell. Each display provides access to basic test configuration and control and makes it possible to run the Model 4005 without an external computer. The display can be operated either as a touch-screen or with the control wheel.

To operate the display:

1. Turn the Control Wheel to scroll through the available parameters.
2. Press the Control Wheel to select a parameter.
3. Turn the Control Wheel to scroll through available values for the parameter.
4. Press the Control Wheel to select a value.

Onboard Display

Real-Time Data

The Real-Time Data screen is the default screen. When the display has been idle for more than 2 minutes, it will automatically revert to this screen. Here you can see the current test parameters. This screen does not accept any inputs.

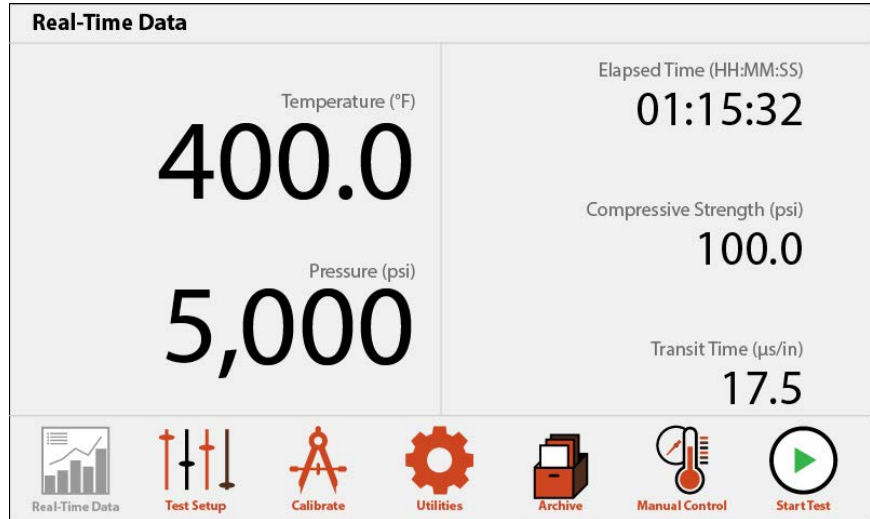

Real-Time Data for a UCA Test

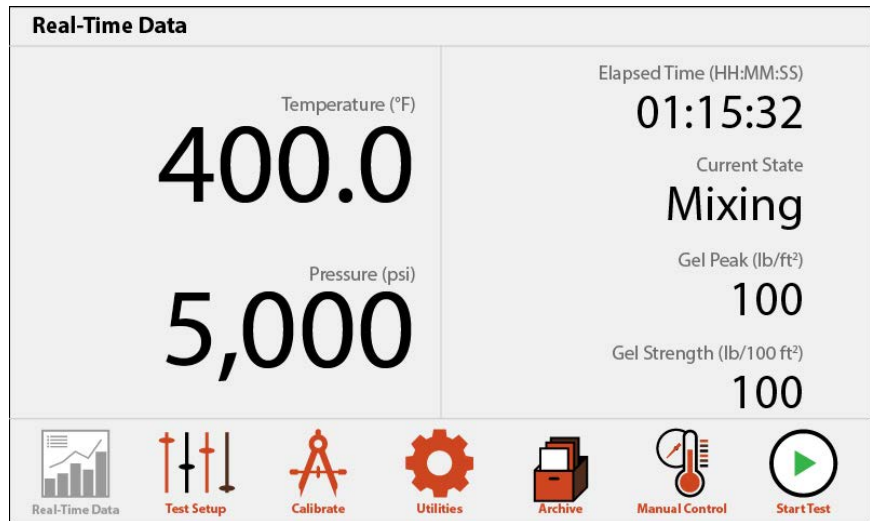

Real-Time Data for an SGSM Test

Onboard Display

Test Setup - Test Config

On the Test Config tab of the Test Setup screen, you can choose the type of test (UCA or SGSM) and define relevant test parameters. Tests created on the onboard display do not have the full range of features available. For access to all features, create the test in the PC software.

1. Go to the Test Setup screen and select “Test Config”.
2. Touch or select the Type parameter to cycle between UCA and SGSM tests. The test parameters will change based on the Test Type.
3. Enter values for each test parameter:

Cement Density: Enter the density of the cement slurry. This will be used to determine the correct compressive strength algorithm in UCA tests.

Conditioning Time: The amount of time the SGSM will condition the cement before it begins measuring gel strength.

Wait Time: The amount of time the bob will pause between gel strength measurement periods.

Test Time: The amount of time the bob will turn while measuring gel strength.

Final Strength: When the peak gel strength meets or exceeds this value, the test will end.

Test Speed: The speed (rpm) the bob will turn to break the gel and measure the gel strength of the cement.

Conditioning Speed: The speed (rpm) the bob will turn during conditioning. This field is disabled if Multiple Conditioning is turned on.

4. Select “Save” when done.

The screenshot shows the 'Test Configuration' screen with the following elements:

- Test Setup** (selected) and **Test Configuration** tabs.
- Test Config** and **Profile** dropdown menus.
- Type** dropdown menu set to **SGSM**.
- Final Strength (Dyne/cm²)** input field with value **0**.
- Cement Density (kg/m³)** input field with value **0**.
- Wait Time (HH:MM:SS)** input field with value **0**.
- Test Speed (rpm)** input field with value **0**.
- Conditioning Time (HH:MM:SS)** input field with value **0**.
- Test Time (HH:MM:SS)** input field with value **0**.
- Conditioning Speed (rpm)** input field with value **0**.
- SAVE** button.
- Navigation Bar:** Real-Time Data, Test Setup, Calibrate, Utilities, Archive, Manual Control, Start Test.

Onboard Display

Test Setup - Profile

On the Profile tab of the Test Setup screen, you can create a Test Profile for your test.

1. Choose a Parameter (Temperature or Pressure).
2. Choose a Step Type:

Ramp: This will increase the temperature or pressure up to the target in a set number of minutes. Enter the ramp time and target.

Step: This will increase the temperature or pressure up to the target as fast as possible. Enter the target temperature or pressure.

Dwell: This will hold the current temperature or pressure for a set number of minutes. Enter the time.

3. Enter the parameters for the step (ramp time, target temperature, etc).
4. Select the “ADD STEP” button.
5. To remove a step, select it in the list and select the “REMOVE STEP” button.
6. When you are finished adding steps, select the “SAVE” button.

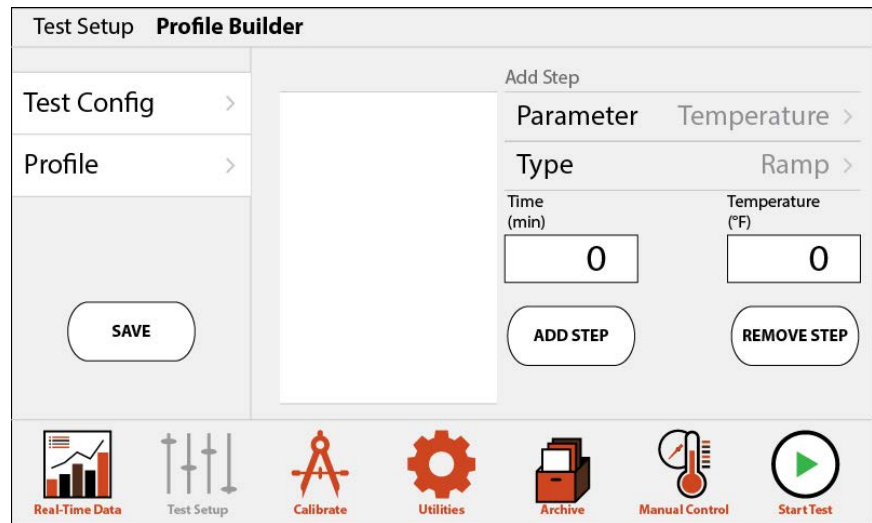

Onboard Display

Calibrate

On the Calibrate screen, the onboard display can calibrate the pressure transducer, thermocouple, ultrasonic transducers (for UCA tests), and load cell (for SGSM tests). It can also perform a Drag Check (for SGSM tests).

1. Select the system (Pressure, Temperature, Transit Time, Load Cell, Drag Check) to calibrate.
2. Follow the onscreen instructions.

Pressure: See page 67.

Temperature: See page 68.

Transit Time: See page 69.

Load Cell: See page 71.

Drag Check: See page 46.

Onboard Display

Utilities

The Utilities screen sets general parameters.

1. Enter the values for each parameter:

Display Temperature: The instrument has two thermocouples. One is in the cement sample in the cell. The other is in the heating jacket (Bath). Use this option to determine which thermocouple will be used to control the temperature. Sample is recommended during testing. But Bath is recommended during pre-heat.

Temperature: Choose either °F (Fahrenheit) or °C (Celsius)

Pressure: Choose units for cell pressure (psi or MPa).

Compressive Strength: Choose units for compressive strength (psi or MPa)

Cement Density: Choose either lb/gal or kg/m³

2. Select “Apply” when done.

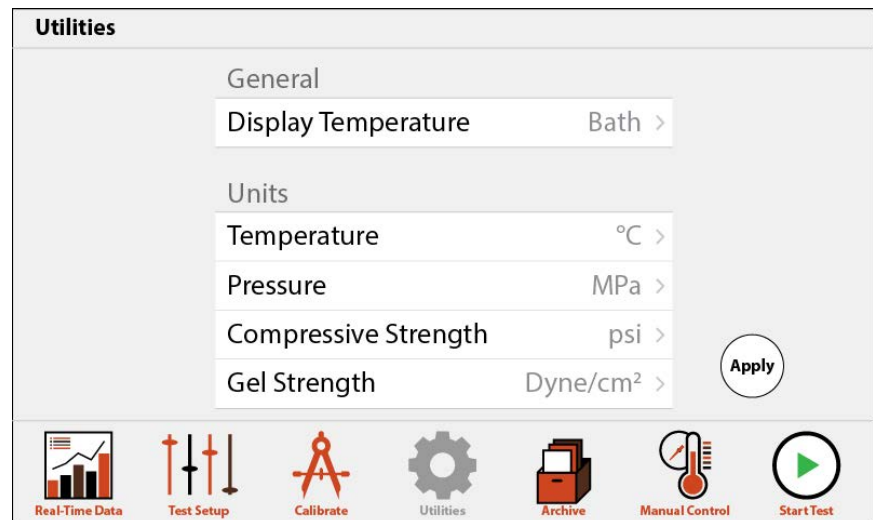

Onboard Display

Archive

On the Archive screen, saved calibrations and tests can be exported to a USB drive.

1. Place a USB drive in the port on the right-hand side of the instrument.

The port has an indicator light to show the status of the inserted drive:

- a. Green: The drive is inserted and supported.
 - b. Amber: The drive is inserted and supported, but low on free space.
 - c. Red: The drive is inserted but not supported. Make sure the drive is formatted in the FAT32 file system.
2. On the left-hand side of the screen, choose either Tests or Calibrations. The list of available tests or calibrations will populate on the right.
 3. Choose the item to export.
 4. Select "Export". The file will be saved to the USB drive.

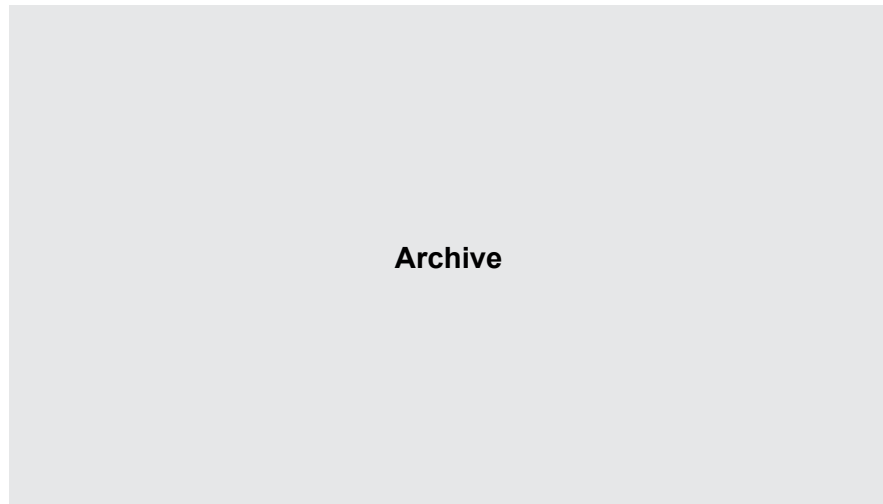

Onboard Display

Manual Control



Note

The Manual Control screen can be used to set the temperature and/or pressure when a test is not running. The HEAT switch must be set to MANUAL to control the temperature. The PRESSURE switch must be set to MANUAL to control the pressure.

1. On the left-hand side of the screen, choose either Temperature or Pressure.
2. Enter the setpoint in the box.
3. Select "SET" when done.

When setting the temperature with Manual Control, the controller will use the thermocouple specified in the Utilities screen (Bath or Cell). If the Cell thermocouple is selected, a thermocouple must be connected to the port on the bulkhead to prevent alarms.

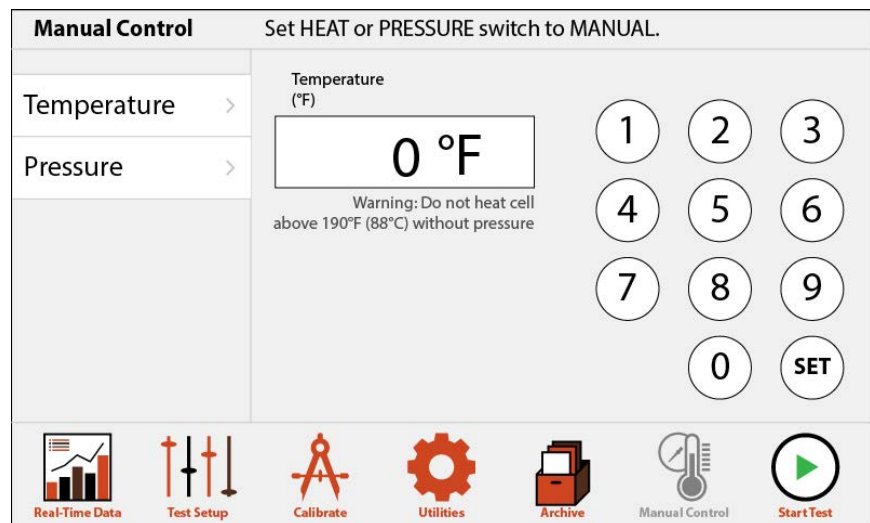

Onboard Display

Start Test

The Start Test button starts a test using the parameters that are currently saved to the internal board. Before pressing the Start Test button, be sure to configure your test parameters on the Test Setup screen (see page 26) or in the PC software (see page 18).



Also note, when saving settings in the onboard display, the settings displayed on the screen will be saved to the board, but other settings that were previously set in the software will be replaced by defaults.



UCA

Cell Assembly

The cell body and both cell caps were manufactured and pressure tested together. All three pieces are serialized. Before assembling the test cell, make sure all three pieces have the same serial number.

For a complete diagram of the test cell, refer to page 74.

Cell Cap Assembly

1. Apply a thin layer of high-temperature grease to the inside surfaces of the two cell caps. Wipe off any excess grease.

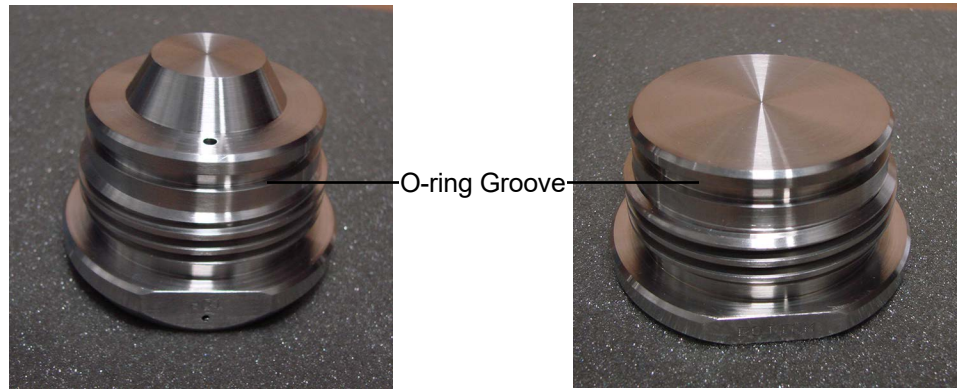

Top UCA Cell Cap

Bottom Cell Cap

2. Apply high-temperature grease to both cell cap o-rings (#123-011).
3. Place an o-ring in the grooves of each cell cap.
4. Make sure the transducers and the transducer holes in the cell caps are clean and free of debris. They can be cleaned with a rag or paper towel. Alcohol can also be used if further cleaning is necessary.



Tip

5. Apply a thin coat of an ultrasonic couplant to the two transducers.

When applying the couplant, apply only the smallest amount necessary to allow for the couplant to be spread out in a very thin layer, evenly over the face of the transducer. Applying too much couplant can interfere with the integrity of the signal that is either transmitted or received by the transducers.



6. Place the top transducer into the hole in the top cell cap. Compress the spring and place the spring holder over it. Tighten the screw with a $\frac{3}{16}$ " allen wrench to secure the spring holder in place.

Cell Assembly

1. The test cell is labeled to indicate which end is the top and which is the bottom. Additionally, you can identify the bottom of the cell by removing both caps and examining the grooves beneath the threads. The end with the smaller groove is the bottom of the cell.



Note

The interior of the cell has a taper with the narrow end at the top and the wide end at the bottom. A hardened cement plug can only be pushed out of the cell from the top.

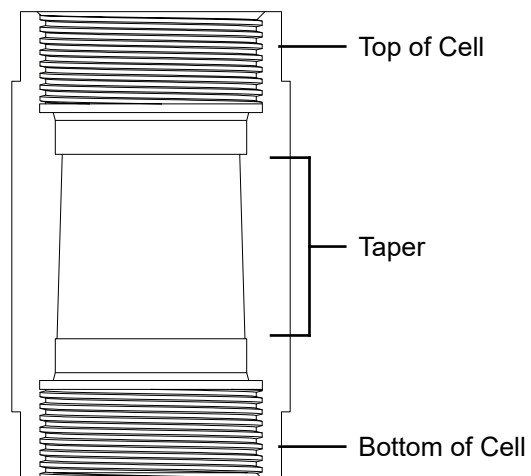



2. Apply a thin layer of high-temperature grease to any surface that will be in contact with cement. This will make cleaning easier when the test is complete.
3. Carefully screw the bottom cell cap onto the test cell.

The cell cap should turn smoothly in the test cell threads. If you encounter resistance, stop turning and unscrew the cap slightly. Then continue turning until the cap is completely tightened.

4. Once the cap is completely tightened, unscrew it one quarter turn. This will facilitate disassembly later.
5. Turn the test cell over and begin filling with the cement slurry. Place the fill gauge on top of the test cell. Fill the cell until the cement touches the bottom of the fill gauge labeled UCA.

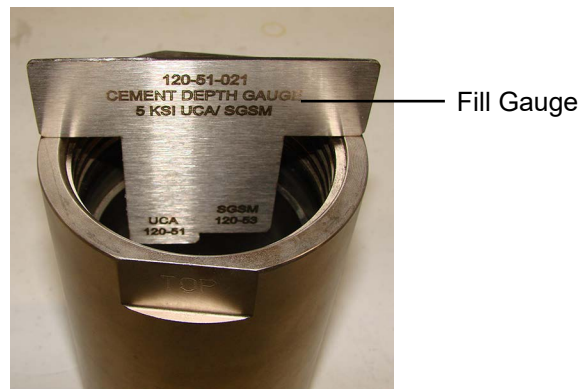

6. Carefully screw the top cell cap into the test cell, just as you did with the bottom cell cap.

UCA

Connecting the Cell



1. Carefully place the cell into the heating jacket.

Make sure the transducer is pressed down completely in the bottom of the heating jacket.

2. Align the cell as shown below.

3. Screw the $\frac{5}{8}$ " connection on the supply line to the bulkhead connector. Leave the connection slightly loose for now.

Make sure the arrow on the filter is pointed toward the cell.

4. Screw the $\frac{5}{8}$ " connection on the high-pressure supply line to the port on the test cell. Use a wrench to tighten it completely.

5. Now use a $\frac{5}{8}$ " wrench to tighten the supply line to the bulkhead connector completely.

6. Screw the thermocouple into the $\frac{5}{8}$ " port on the cell cap and leave it loose. Plug the thermocouple into the port on the unit cabinet.

7. Plug the transducer into the port on the unit cabinet.

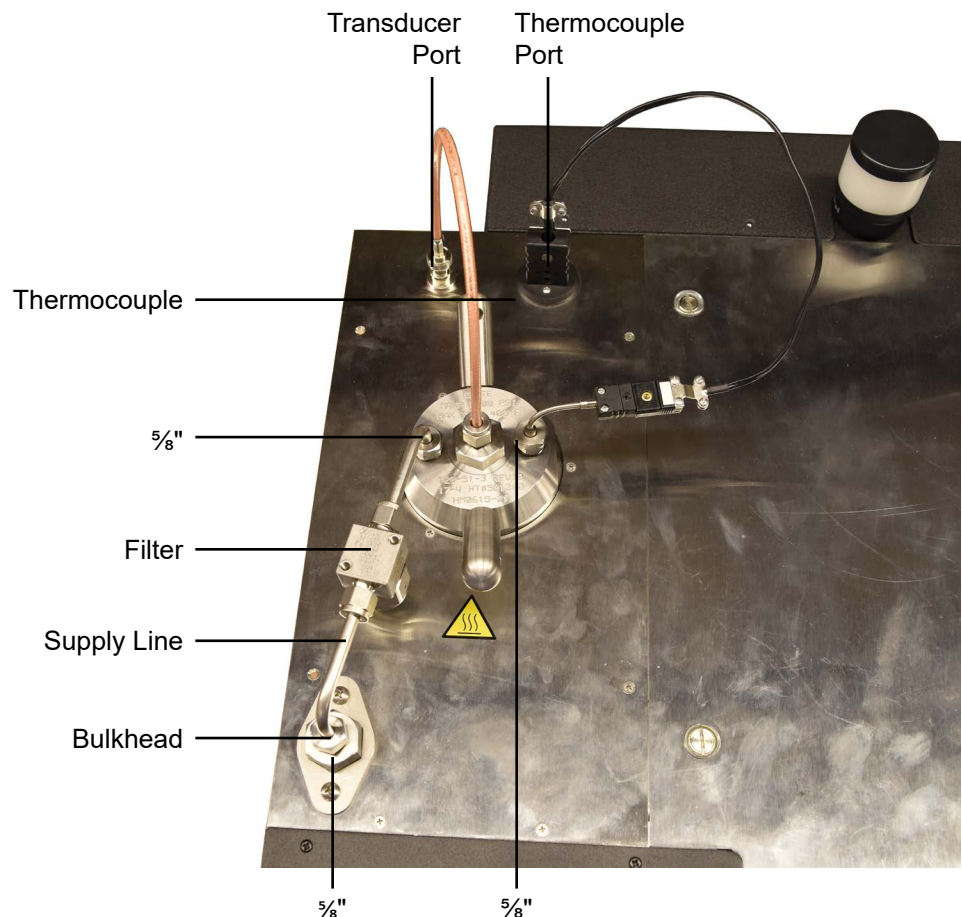

Use of this equipment in a manner not specified by the manufacturer may impair the protections provided by the equipment.

1. Set up the test in the software (page 12) or in the onboard display (page 26).
2. Create a Test Profile in the software (page 18) or in the onboard display (page 27).
3. Define any events (page 22) or calculated values (page 23) in the software.
4. Assemble the test cell (page 33), load it into the heating jacket, and make all the necessary connections (page 36).



Note

Make sure the thermocouple is not tightened completely.

5. Slowly turn the Water Supply valve to “Fill”.
6. Watch for water to leak from the thermocouple. When the water starts to leak, immediately tighten the thermocouple with a wrench to seal the cell. This will ensure that all air has been purged from the cell.
7. Set the “HEAT”, “COOL”, and “PRESSURE” switches to “AUTO”.
8. Turn the Water Supply valve to “OPERATE”.
9. Click or touch the “Start Test” button.



Tip

Solid particles and air bubbles within the cement slurry can adversely affect the results of your test. The first Transit Time reading should be at least 10 μ s. If it is less than 10 μ s:

- a. Wait a few minutes to see if the problem corrects itself.

For typical slurries, the problem should correct itself in about five minutes. More advanced slurries may take several minutes longer.

- b. If the transit time remains below 10 μ s, restart the test by clicking “Stop Test” and then “Start Test”.
- c. If the problem persists, remix the slurry and start the test again. To avoid this problem, carefully follow the mixing procedure in API Specification 10.



Note

UCA

Stopping the Test

1. When the test has finished all of the programmed steps or has met the specified end conditions, the system will automatically turn off the heat and turn on the cooling. If the cell temperature is over 190°F (87.8°C), the unit will maintain the required 1,000 psi (6.9 MPa) to prevent the sample from boiling. Once the cell temperature is below 190°F (87.8°C), the cell pressure will vent completely.
2. When the cell has cooled completely, turn the “HEAT”, “COOL”, and “PRESSURE” switches off.
3. Turn the Water Supply valve to “DRAIN”.
4. Unscrew and remove the high-pressure supply line from the cell cap and the instrument cabinet.
5. Unplug the thermocouple and transducer.
6. Lift the cell out of the heating jacket.



When removing the test cell, pay special attention to the transducer and make sure it doesn't pull off the end of the transducer cable with the cell.

Use caution. The test cell may contain a small amount of air at high temperature and/or pressure.

UCA

Disassembling and Cleaning the Test Cell



Tip

The test cell must be cleaned immediately after every test. Any cement left in the test cell will harden and could damage the equipment. Remove all o-rings and seal rings and clean them individually. Carefully inspect them and discard any that show damage or wear.

The cement in the cell will be solid. It may be necessary to press the cement block out. Follow the procedure below:

1. Remove both cell caps and pour off any excess water.

If the cell caps on the test cell will not turn, use a rubber mallet and strike the top and bottom of the test cell.

2. Remove the cement plug from the cell by pressing from the top down.
3. Clean all surfaces of the test cell with soap and water.

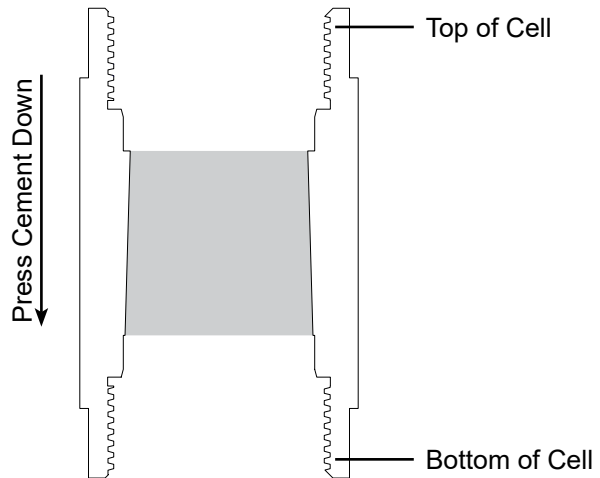

Do not use any type of decontamination or cleaning agents as they may cause a hazard as a result of a reaction with parts of the equipment or with material contained within. If there is any doubt about the compatibility of a decontamination or cleaning agent, please contact OFITE Technical Support.



The cell body and both cell caps were manufactured and pressure tested together. All three pieces are serialized. Before assembling the test cell, make sure all three pieces have the same serial number.

For a complete diagram of the test cell, refer to page 75.

Bottom Cap Assembly

1. Inspect the transducer port to make sure that it is clean and free of debris. Dried transducer couplant can accumulate on the sides and bottom of the port. This couplant must be cleaned from the port as well.
2. Tighten the jaws of the vice on the flats of the cell cap with the threads facing up.
3. Apply a thin layer of high-temperature grease to the surface of the bottom cell cap that meets with the cement. Wipe off any excess grease.
4. Place an o-ring (#123-011) in the o-ring groove on the bottom cell cap.
5. Apply more high temperature grease to the o-ring.



The o-ring should be inspected for signs of degradation before installing a new o-ring.



Cell assembly

The test cell is labeled to indicate which end is the top and which is the bottom. The interior of the cell has a taper with the narrow end at the top and the wider end at the bottom to facilitate cement plug removal. Apply a thin layer of high-temperature grease to the surfaces that will be in contact with cement. This will make cleaning easier when the test is complete.

1. Carefully screw the cell body onto the bottom cell cap completely. Then unscrew the cell body $\frac{1}{4}$ of a turn. This will facilitate disassembly later.

The cell body should turn smoothly onto the cell cap. If you encounter resistance, stop turning and unscrew the body slightly. Then continue turning until the cell body is completely tightened.

If the cell body still does not screw onto the cell cap, remove the cell body and check the threads on both the cell body and the cell cap for debris.

2. Remove the cell body and bottom cell cap from the vise in preparation for the top cell cap assembly.



Note



Note

Top Cap Assembly

1. Inspect the transducer and thermocouple ports to make sure that they are clean and free of cement.
2. Install the thermocouple into one of the ports on the top cap of the SGSM test cell. Tighten the thermocouple completely then loosen it ¼ of a turn.

The two ports are interchangeable.

3. Tighten the jaws of the vice on the flats of the cell cap with the threads faced up.
4. Insert retaining ring into the lower internal ring groove of the cell cap so the gap clears the thermocouple as shown below.

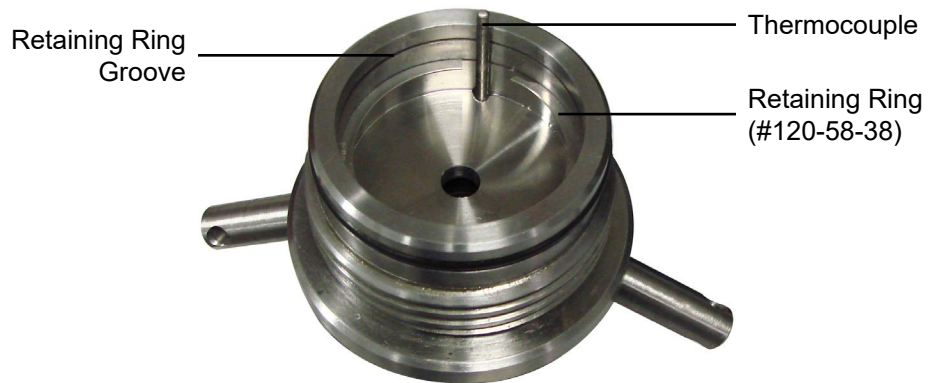

5. Insert the diaphragm into the cell cap so the gap clears the thermocouple.
6. Insert the other internal retaining ring into the groove above the diaphragm so the gap clears the thermocouple as shown below.
7. Place an o-ring on the cell cap.



Low Pressure SGSM

8. Apply high temperature grease to the threads, seal ring, o-ring, and the Retaining ring.



9. Install the two bushings. One bushing goes into the hole in the top of the top cell cap. The other goes inside the Mounting Adapter.

Make sure the bushings sit flush with the metal.

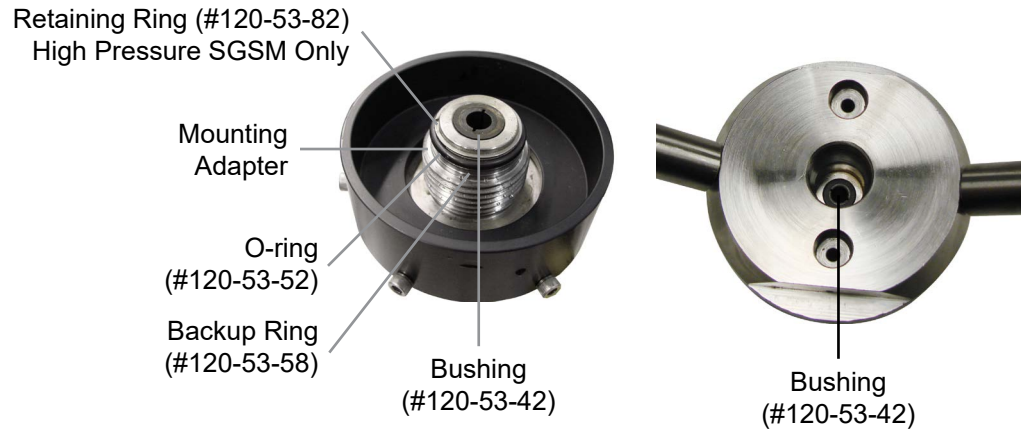

10. Secure the mounting adapter (120-58-04) with the short end facing up.
11. Place the upper backup ring (#120-53-58) around the top of the mounting adapter with the o-ring (#120-53-32) on top of it. The backup ring should be oriented with the taper pointing away from the o-ring.
12. Place a retaining ring (#120-53-82) on the mounting adapter to hold the o-ring in place.
13. Secure the mounting adapter with the longer end of the shaft pointed up. Place the lower backup ring (#120-53-59) around the bottom of the mounting adapter with the o-ring (#120-53-31) on top of it. The backup ring should be oriented with the taper pointing away from the o-ring.
14. Install the retainer ring (#120-58-05) above the o-ring.



Metal Seal Ring
(Cross Section)

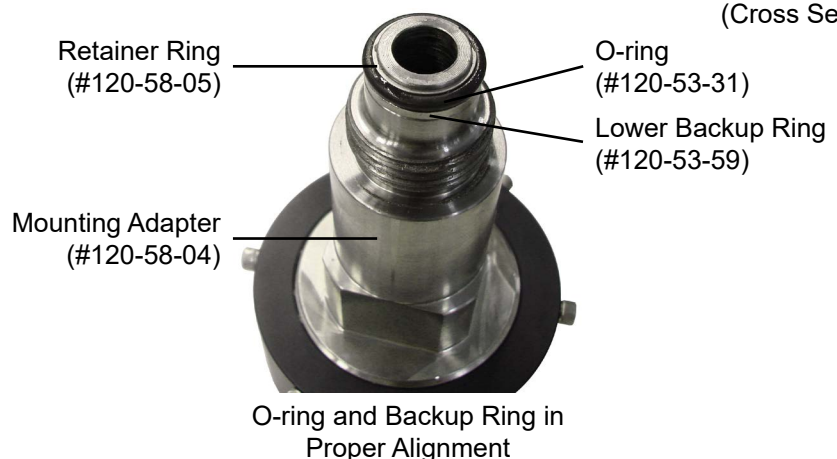

15. Install the SGSM base to the mounting adapter as shown below. Screw the threads facing inward and the allen heads on the outside of the base.
16. Insert the magnet shaft assembly (#120-58-010) into the SGSM base, threads first with the magnet facing upward.
17. Lightly grease the threads of the mounting adapter that secure the magnet cover.
18. Place the magnet cover over the magnet and screw it tight.
19. Lightly grease the threads that secure the plug and gland.
20. Install the plug and gland. Tighten them, then loosen them ¼ of a turn.

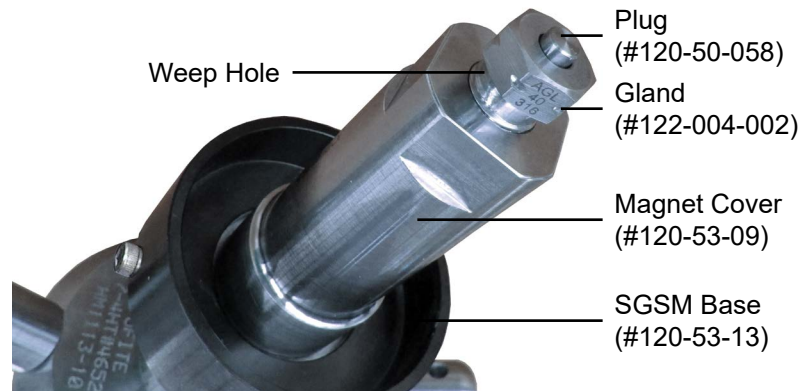

21. Secure the top cell cap in a vise with the threads facing down.
22. Carefully insert the assembled base and bob shaft through the top of the cap, with the threads of the bob shaft going in first.
23. Once the base reaches the top of the cell cap, screw the assembly onto the cell cap.

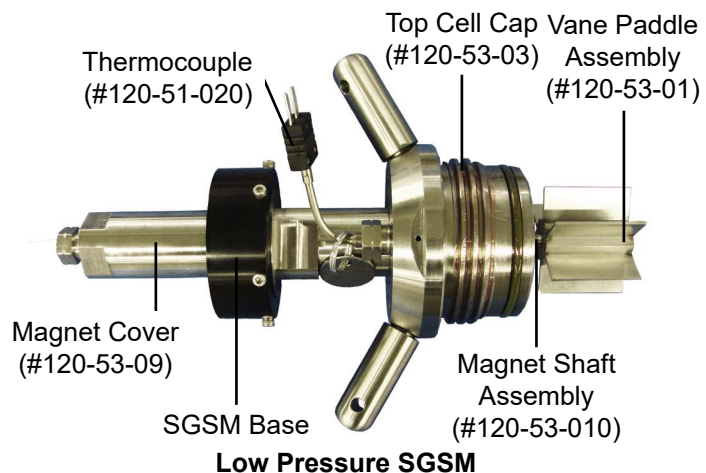



Note

24. With a set of calipers, measure the diameter of the bob along all three axes of the vane. Measure the height of the bob blades in three places. Record the average diameter and average height and enter them in the Setup screen. Refer to page 14.

The bob should be measured every 3 months.



Bob

Calipers

25. Screw the bob onto the bob shaft. Hold the shaft in place with the supplied $\frac{3}{16}$ " combination wrench (#120-53-81) tightening the bob.

The bob screws counterclockwise onto the bob shaft with a left-handed thread.



SGSM

Drag Check



Before running a gel strength test, it is recommended you perform a Drag Check. Run the drag check in air.

Always perform a Drag Check after calibrating the transducer. During the Drag Check, the SGSM will run at 2rpm and the total time for the Drag Check will be 33 seconds.

1. Carefully screw the assembled SGSM top cap onto the test cell.

The cell cap should turn smoothly in the test cell threads. If you encounter resistance, stop turning and unscrew the cap slightly. Then continue turning until the cap is completely tightened.

2. Once the cap is completely tightened, unscrew it one quarter turn. This will facilitate disassembly later.
3. Install the SGSM head to the base.
4. Connect the SGSM Head to the UCA with the supplied Ethernet cable.
5. Access the Drag Check routine:
 - a. In the software click Utilities → Cell 1 (or Cell 2) → Calibrate → SGSM Drag Check.
 - b. In the Onboard Display, go to the Calibrate screen and select “Drag Check”.
6. Allow the test to run for 33 seconds and select “Save”.
7. Repeat the drag check test to ensure consistency.



Note

The test must have a Delta Raw Force less than 2 gf and a MaxRawForce less than 85gf. If the value jumps wildly from one check to the next, this is an indication that there is a problem with one or more of the components of the system (bushing, shaft, load cell, etc.). You will need to inspect the SGSM assembly for problems. See page 63 for troubleshooting instructions.

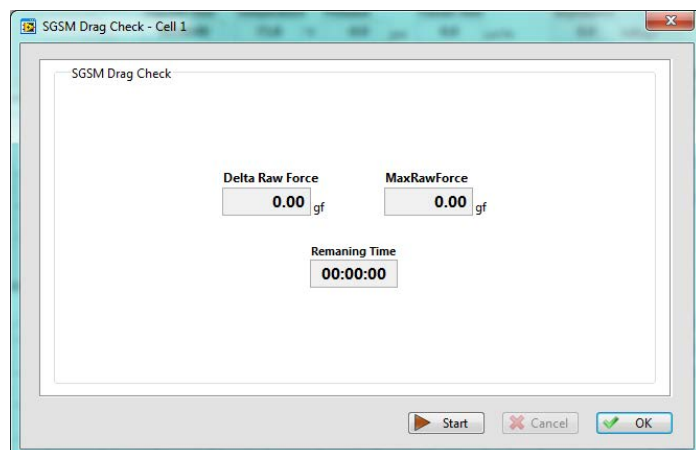

SGSM

Preparing the Test Cell

Filling the Cell

1. Once the slurry has been mixed, place the fill gauge on top of the test cell.
2. Fill the cell until the cement touches the bottom of the fill gauge to the side labeled "SGSM".



Fill Gauge
(#120-51-021)

3. Carefully screw the top cell cap onto the cell body completely. The cell cap should turn smoothly onto the cell body. If you encounter resistance, stop turning and unscrew the cap slightly. Then continue turning until it tightens completely.



Tip

Unscrew the top cell cap $\frac{1}{8}$ of a turn. This will facilitate disassembly later.

SGSM

Connecting the Test Cell



1. Carefully place the cell into the heating jacket.

Make sure the transducer is pressed down completely in the bottom of the heating jacket.
2. Align the cell as shown below.
3. Screw the $\frac{5}{8}$ " connection on the high-pressure supply line to the bulkhead connector. Leave the connection slightly loose for now.

Make sure the arrow on the filter is pointed toward the cell.
4. Screw the $\frac{5}{8}$ " connection on the high-pressure supply line to the port on the test cell. Use a wrench to tighten it completely.
5. Now use a $\frac{5}{8}$ " wrench to tighten the supply line to the bulkhead connector completely.
6. Screw the thermocouple into the $\frac{5}{8}$ " port on the cell cap and leave it loose. Plug the thermocouple into the port on the unit cabinet.
7. Carefully place the SGSM Head Assembly on top of the test cell. Connect the Head Assembly to the UCA with the supplied Ethernet cable.

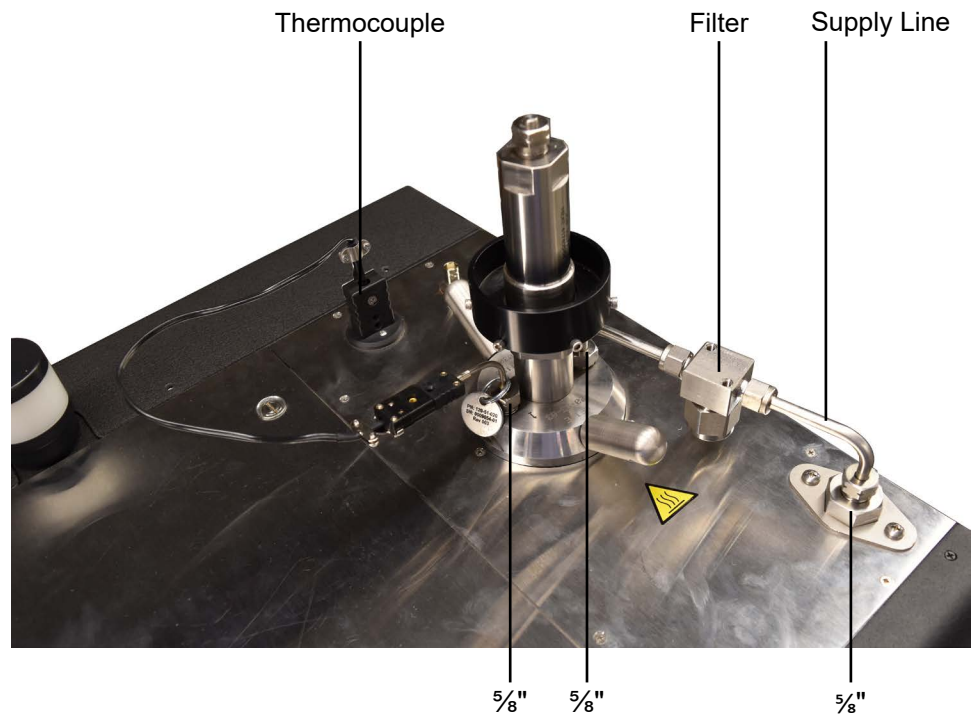

SGSM

Starting the Test



Note

Use of this equipment in a manner not specified by the manufacturer may impair the protections provided by the equipment.

1. Set up a test in the software (page 14) or in the onboard display (page 26).
2. Create a Test Profile in the software (page 18) or in the onboard display (page 27).
3. Define any events (page 22) or calculated values (page 23) in the software.
4. Assemble the test cell (page 40), load it into the heating jacket, and make all the necessary connections (page 48).

Make sure the thermocouple is not tightened completely.

5. Slowly turn the Water Supply valve to "Fill".
6. Watch for water to leak from the thermocouple. When the water starts to leak, immediately tighten the thermocouple with a wrench to seal the cell. This will ensure that all air has been purged from the cell.
7. Turn the Water Supply valve to "OPERATE".
8. Set the "HEAT", "COOL", and "PRESSURE" switches to "AUTO".
9. Click or touch the "Start Test" button.

SGSM

Stopping the Test

1. When the test has finished all of the programmed steps or has met the specified end conditions, the system will automatically turn off the heat and turn on the cooling. If the cell temperature is over 190°F (87.8°C), the unit will maintain the required 1,000 psi (6.9 MPa) to prevent the sample from boiling. Once the cell temperature is below 190°F (87.8°C), the cell pressure will vent completely.
2. When the cell has cooled completely, turn the “HEAT”, “COOL”, and “PRESSURE” switches off.
3. Turn the Water Supply valve to “DRAIN”.
4. Unscrew and remove the high-pressure line from the cell cap and the instrument cabinet.
5. Carefully lift the SGSM head off the cell and set it aside.
6. Unplug the thermocouple.
7. Lift the cell out of the heating jacket.

When removing the test cell, pay special attention to the transducer and make sure it doesn't pull off the end of the transducer cable with the cell.



Use caution. The test cell may contain a small amount of air at high temperature and/or pressure.

SGSM

Evaluating Test Data

When a test is complete, the software automatically generates a .jpg file of the chart and a data file that can be opened in Excel. Both of these files will be stored in the folder specified in the “Archive Path” field on the Setup screen (see page 11 for more information).

Gel Strength Peaks			
Elap Time	Temp (°F)	Gel Strength (lb/100ft ²)	Pressure (psi)
0:17:41	89.7	13.82	5351.9
0:27:58	100.5	198.2	5380.91
0:39:04	102.8	438.22	5177.86
0:50:10	102.2	695.92	4800.76

The SGSM data file will show the elapsed test time, temperature, pressure, and gel strength at each peak during the test. This differs from the UCA data file, which includes data points at a specific time interval throughout the test.

The SGSM chart shows the temperature, pressure, and gel strength over time. The software also generates a trend line connecting the peaks of the gel strength line.

At the top of the SGSM chart are entries for “Threshold Strength” and “Final Strength”. This shows the time at which the cement reached each gel strength. These values are set in the Setup screen (page 14).

The measurement time for the static gel strength begins once the test has completed the “Conditioning Time” entered in the setup screen. These times are interpolated based on the trend line generated from the peaks that are measured at the end of each “SGSM Test Period”.



Note

When Multiple Conditioning is on, the Interpolated Data will only reflect data collected from the first cycle.

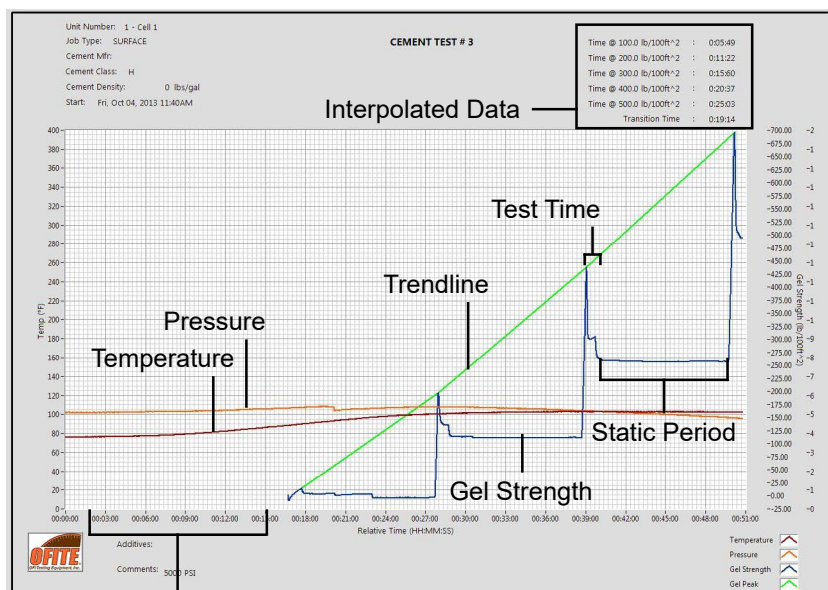

SGSM

Disassembling and Cleaning the Test Cell



Note



Note



Note



The test cell must be cleaned immediately after every test. Any cement left in the test cell will harden and could damage the equipment. Clean all surfaces of the test cell with soap and water.

Remove all o-rings, snap rings, and bushing and clean them individually. Carefully inspect them and discard any that show damage or wear.

If the cement sets during an SGSM test, the bob and bob shaft will set with the cement in the test cell. If this happens, it may be possible to remove bob without damaging the equipment.

There are two procedures for removing the SGSM assembly from the cell that has hardened cement. The first procedure attempts to save the magnet and shaft. This procedure will only work if the threads on the shaft have been heavily greased. The shaft will need to twist free from the bob and any cement that has set around it.

If the first procedure fails, then the second procedure will remove the magnet and shaft from the cell. However, both the magnet head and the bob shaft will be destroyed and will not be reusable. The bob itself should be reusable for further testing.

To avoid damaging the equipment, make sure all surfaces that will be in contact with the cement are covered in grease before assembling the cell.

Procedure 1:

Tools Needed:

- 10" Crescent Wrench
- $\frac{5}{8}$ " Wrench
- $\frac{1}{2}$ " Strap Wrench
- Soft Face Hammer
- Cell Cap Wrench
- Heavy Duty Vice
- Small Sledge Hammer
- Rock Chisel
- Knock Out Tool

A hardened cement plug can only be pushed out of the cell from the top to the bottom. Secure the test cell in a heavy-duty vice.

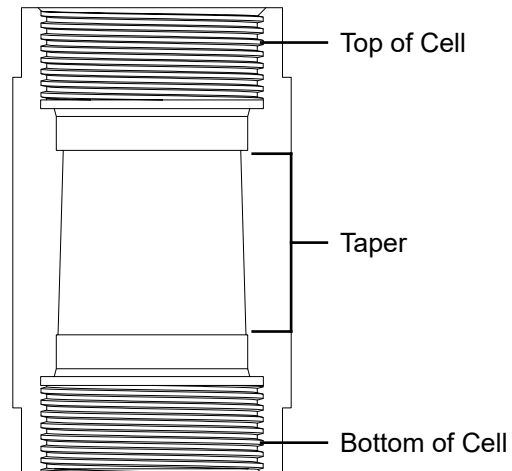

1. Tighten the jaws of the vice on the flats of the test cell with the SGSM Drive Assembly facing up.
2. Use a crescent wrench to hold the bob shaft housing in place.
3. Unscrew the black SGSM base collar.
4. Unscrew the magnetic housing on top of the cell.
5. Fit the strap wrench around the magnet on top of the shaft.



6. The bob shaft has a left-handed thread. Using the strap wrench, unscrew the shaft from the bob by rotating the shaft clockwise. The magnet is press fit onto the shaft and should move as one piece. If the magnet turns on the shaft, skip to Procedure 2.
7. When the shaft has disengaged completely from the bob, carefully remove the shaft by grasping the magnet and pulling straight up.
8. Use a $\frac{5}{8}$ " wrench to loosen the thermocouple connection and pull it straight up to make sure it pulls clear of the set cement.
9. Remove the drive adapter by unscrewing it from the cell cap with a crescent wrench.



10. Use the cell cap wrench to remove the lid of the test cell.
11. Turn the test cell over and secure it in the vice with the end labeled “BOTTOM” will be facing up.
12. Use the cell cap wrench to remove the bottom cell cap.
13. Remove the cell from the vice.
14. Set the cell upright on a counter with the end labeled “TOP” facing up.
15. Using a hammer and the knock out tool and/or a cement press, remove the cement plug from the test cell.



Tip



Note

Be sure to apply force only to the top of the cement plug.

Take extra precautions as the bob can be damaged during this operation.



16. Note the top and bottom of the cement plug. The top of the plug will have a hole in the top from which the shaft was pulled.
17. Once the cement plug has been removed, set the plug on its side.
18. Using a small chisel, begin chipping at the plug about ½” from the bottom.



Be careful not to damage the vanes on the bob.



19. Remove the cement from the bottom of the plug in small chunks until you expose one of the vanes on the bob.
20. Set the plug upside down on the counter.
21. Place the chisel next to the exposed vane and begin chipping downward away from the vane.
22. Proceed around the bob by removing the cement from between the vanes.

Procedure 2:

Tools Needed

- 10" Crescent Wrench
 - $\frac{5}{8}$ " Wrench
 - Channel Locks
 - Soft Face Hammer
 - Cell Cap Wrench
 - Heavy Duty Vice
 - Small Sledge Hammer
 - Rock Chisel
 - Knock Out Tool
1. Secure the SGSM cell in a heavy-duty vice.
 2. Use a crescent wrench to hold the bob shaft housing in place.
 3. Unscrew the magnetic housing on top of the cell.
 4. Remove the magnetic housing.
 5. Use a $\frac{5}{8}$ " wrench to loosen the thermocouple connection and pull it straight up to make sure it pulls clear of the set cement.



6. Expose a section of the bob shaft:
 - a. Use a crescent wrench to unscrew the bob shaft housing.



Do not remove the housing completely!

- b. Raise the magnetic housing enough so that you can pull the thermocouple clear.
3. Unscrew the cell cap 2 or 3 turns.
4. Screw the cell cap back down.
5. Screw the bob shaft housing back down.
6. Grip the exposed area of the shaft with a pair of channel locks.



7. The bob shaft has a left-handed thread. Loosen the shaft by turning the channel locks clockwise.
8. When the threads are fully disengaged, carefully remove the shaft.
9. Remove the magnetic housing.



Note

The action of removing the shaft will destroy the upper bushing.

10. Use a cell cap wrench to remove the cell cap.
11. Turn the test cell over and secure it in the vice with the end labeled "BOTTOM" will be facing up.
12. Use the cell cap wrench to remove the bottom cell cap.
13. Remove the cell from the vice.
14. Set the cell upright on a counter with the end labeled "TOP" will be facing up.



Tip



Note

- Using a hammer and the knock out tool and/or a cement press, remove the cement plug from the test cell.

Be sure to apply force only to the top of the cement plug.

Take extra precautions as the bob can be damaged during this operation.



- Note the top and bottom of the cement plug. The top of the plug will have a hole in the top from which the shaft was pulled.

- Set the plug on its side.

- Using a small chisel, begin chipping at the plug about 1/2" from the bottom.

- Remove the cement from the bottom of the plug in small chunks until you expose one of the vanes on the bob.



- Set the plug upside down on the counter.

- Place the chisel next to the exposed vane and begin chipping downward away from the vane.

- Proceed around the bob by removing the cement from between the vanes.

Do not use any type of decontamination or cleaning agents as they may cause a hazard as a result of a reaction with parts of the equipment or with material contained within. If there is any doubt about the compatibility of a decontamination or cleaning agent, please contact OFITE Technical Support.



Maintenance

Maintenance Schedule

Procedure	Schedule
Calibrate Load Cell	<ul style="list-style-type: none">- After any mechanical components are changed (bob, shaft, bushings, transducer, etc.)- Monthly
Replace Bushings	<ul style="list-style-type: none">- If the bushings show signs of damage or wear- When the SGSM Drag Check results are too high (page 46)
SGSM Drag Check	<ul style="list-style-type: none">- Before every test- After load cell calibration
Bob Measurements	<ul style="list-style-type: none">- Every 3 Months
O-ring Replacement	<ul style="list-style-type: none">- After 400°F (204.4°C) tests or as needed
Calibrate Temperature	<ul style="list-style-type: none">- Monthly (page 68)
Calibrate Pressure	<ul style="list-style-type: none">- Annually (page 67)
Replace Fuses	<ul style="list-style-type: none">- As needed (page 59)

Maintenance

Fuses

The instrument has two fuses. If the unit will not power on, check both fuses to make sure they are not blown.

1. Remove the back panel and inspect the fuses.
2. If a fuse is blown, a red LED light will come on below the housing.
3. Unplug the power cord leading to the UCA.
4. Depress the tab on the bottom of the fuse housing and flip the housing up.
5. Open the door on the side of the fuse housing.
6. Replace the blown fuse.
7. Close the door on the fuse housing and push the housing down back into place.
8. Plug the power cord back into the UCA.
9. Check the system to ensure it is working again.

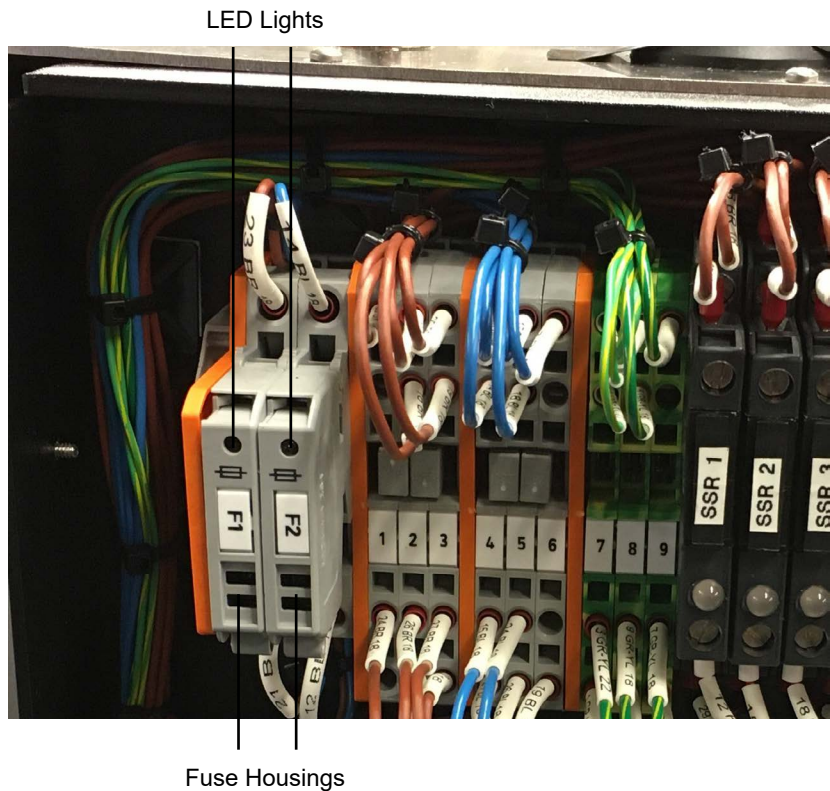

Maintenance

Rupture Disk

If the pump is running but no pressure is building in the test cell, this may indicate that the rupture disk has blown. To replace the rupture disk:

1. Make sure there is no pressure on the system.
2. Set the “PRESSURE” switch to “OFF”.
3. Turn the Water Supply valve to “DRAIN”.
4. Each cell has its own rupture disk. These are located just inside the side panel next to the heating jacket. Remove the side panel.
5. Disconnect the plumbing from all three ports on the rupture disk housing.
6. Remove the rupture disk and replace it with a new one.
7. Reconnect the plumbing lines to the ports on the rupture disk housing.

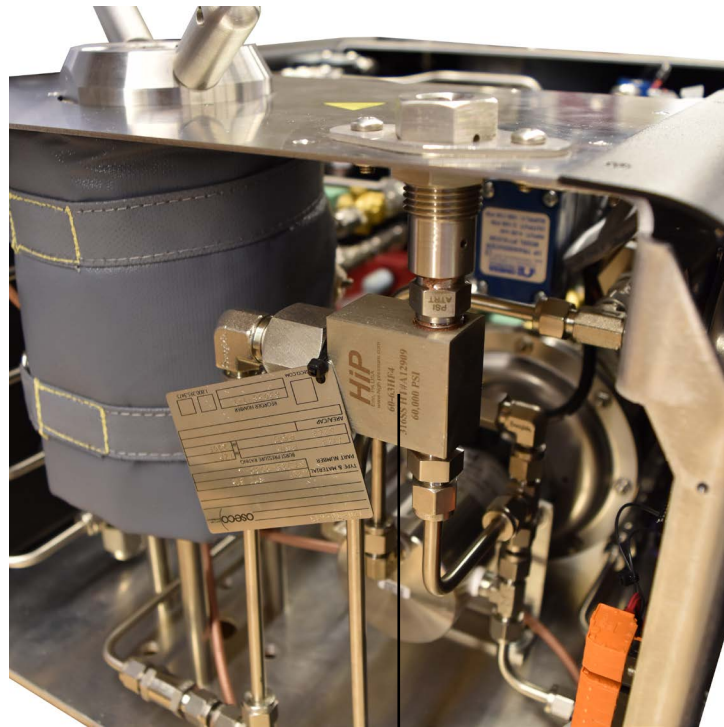

Rupture Disk

Maintenance

Filters

If the pump is running but no pressure is building in the test cell, this may indicate that a filter is clogged. Each cell has a filter on the supply line outside the cabinet. There is also a filter on the main water supply inside the cabinet.

1. Make sure there is no pressure on the system.
2. Set the "PRESSURE" switch to "OFF".
3. Turn the Water Supply valve to "DRAIN".
4. To access the filter on the water supply, remove the panel on the left-hand side of the unit. The filter is near the base plate at the back of the cabinet.

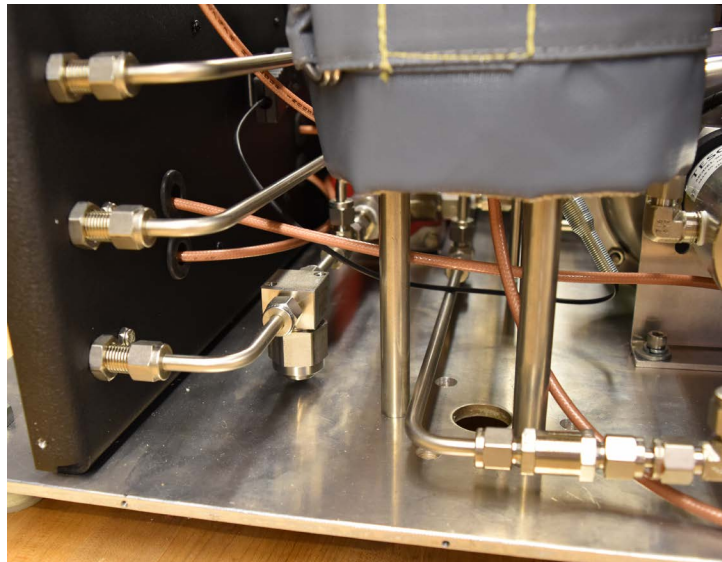

5. Unscrew the hexagonal fitting from the filter housing. Make a note of the direction of the arrow on the filter.
6. Remove the filter element and clean it thoroughly, removing any debris.
7. Put the filter element back in and screw it back onto the filter housing. Make sure the arrow on the filter is pointing away from the back of the cabinet.

At times moisture can build up in the air lines. The air filter inside the instrument cabinet collects water from the lines. Periodically check the air filter for moisture build up and, if necessary, purge it.

1. Remove the top panel. The air filter is just underneath the top panel at the back of the cabinet.
2. Place a paper towel underneath the air filter to prevent water from spraying inside the cabinet.
3. Use the paper towel to press the pressure release button to remove water in the line.

Air Filter

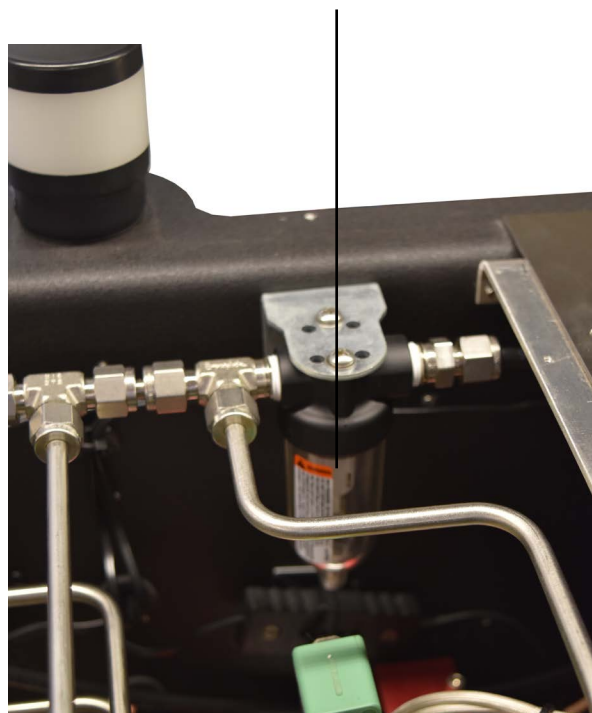

Maintenance

Troubleshooting

Symptom	Cause	Remedy
Power		
There is no power to the machine	The main power cord is not plugged in.	Ensure the power cord(s) is firmly into the wall and the machine
	One of the fuses for the main power supply is blown	Check and replace the fuses (page 59)
Heating / Cooling		
The unit is not heating	The heater switch is not on	Turn the heater switch to the "AUTO" or "MANUAL" position
	Temperature overshoot tripped LF Controller	Turn main power off and then back on. Make sure unit is not overheating
The unit is overheating	The thermocouple is not plugged in	Plug in the thermocouple
The unit is not able to maintain temperature or the temperature is cycling uncontrollably	The coolant water is on	Turn off the cooling water
	The thermocouple is not plugged in	Plug in the thermocouple

Symptom	Cause	Remedy
Pressure		
The unit will not hold pressure	There is a leak at one of the fittings	Trace the tubing and tighten the leaking connection
	The cell o-rings are worn or not seated properly	Disassemble the cell and inspect all o-rings. Discard any that show signs of damage or wear
The unit will not build pressure	There is a leak at one of the fittings	Tighten the leaking connection
	The pump is broken (not cycling, constantly cycling)	Replace the pump
	The rupture disk is blown	Replace the rupture disk (page 60)
	If there are no visible leaks, then there may be an internal leak caused by clogged tubing or a faulty air pressure valve.	Inspect filters (page 61) and replace if needed. If the tubing is clogged or the air pressure valve has failed, contact OFITE Technical Support.
Thermocouple		
Thermocouple will not fit into the cell cap	The port is filled with cement	Clear the cement blockage
	The thermocouple is bent	Replace the thermocouple
	The hub collar is too low on the thermocouple shaft	Screw the collar up until there are 2 threads showing

Symptom	Cause	Remedy
Software		
There is no transit time	The transducers are dirty	Clean the transducers
	Too much couplant has been applied to the transducers	Wipe off the transducers and apply a smaller amount of couplant to the transmitter surface
	The transducer cables have been damaged	Replace the transducer cables
	The transducers have exceeded their useful life	Replace the transducers
Trace lines are missing from the graph	The boxes for each line are unchecked	Check the appropriate boxes
Leaks		
Water is not flowing to the cell	The filter is plugged	Clean the filter (page 61)
	The fill tubing is plugged	Check the tubing for obstruction
	The fittings and/or cell cap openings are clogged with cement	Check the openings and clean if necessary
Water is leaking from the fitting	The threads have been damaged	Replace the fitting
	The collar on the thermocouple connection is too high or too low	Adjust the collar until 2 threads are exposed
	Cement has clogged the inner surface of the port	Clean cement out of the port

Symptom	Cause	Remedy
Leaks (Continued)		
The test cell is leaking cement	The o-ring has been damaged	Replace the o-ring
	The o-ring has come out of the groove	Reseat the o-ring
Weak or intermittent transit time signal during calibration or test	Dirty transducers or transducer cavity	Remove and clean both the transducers and transducer cavity.
	Worn transducer cables and/or BNC connections	Remove and check the cables for kinks and connections for dirty or worn area. Clean or replace as necessary.
	Excessive transducer couplant used	Clean transducers
	Degraded transducers	Replace transducers
	Couplant used is not rated for the test temperature	Remove and clean the transducers and reapply the proper couplant
Drag Check (SGSM Only)		
If the Peak Values are not consistent between tests with just the Head Assembly versus test in water	Load cell is out of calibration	First, calibrate the Load cell (page 71).
	The Magnet Shaft Assembly is bent	Disassemble the SGSM cell cap and make sure the shaft is not bent.
	Bushings may be damaged or worn	Inspect the bushings for damage or wear. Replace any damaged or worn components and run the drag check again.

Calibration

Pressure Transducer

The pressure should be calibrated on new instruments and whenever the pressure transducer has been replaced. For further assistance, contact OFITE Technical Support.

1. Assemble the UCA cell (page 33), but do not fill it with cement.
2. Carefully place the cell into the heating jacket and attach the water supply line (page 36). Do not put the thermocouple into the cell.
3. Connect a calibrated gauge to the thermocouple port on the cell cap but do not tighten it complete.
4. Slowly turn the Water Supply valve to "FILL".
5. Watch for water to leak from the thermocouple port. When water starts to leak, immediately tighten the gauge with a wrench to seal the cell. This will ensure that all air has been purged from the cell.
6. Set the Pressure switch to "AUTO".
7. Turn the Water Supply valve to "OPERATE".
8. Access the pressure calibration:
 - a. In the software, select Utilities → Cell 1 (or Cell 2) → Calibrate → Pressure Transducer.
 - b. In the Onboard Display, go to the Calibration screen and select "Pressure".
9. The calibration routine will go through a series of pressures. At each one, wait for the value on the calibrated gauge to stabilize and then enter it in the "Calibrated Gauge" field. Then click the "Accept" (software) or ">" (onboard) button.
10. When all steps are complete, you will see the calibration data, including a Pass or Fail.
11. Click the "Save" (software) or "Apply" (onboard) button.

Calibration

Thermocouple

Calibrating the Thermocouple requires the use of a calibrated heating device.

1. Start the software.
2. Connect the thermocouple to a dry block calibrating device.
3. Set the Pressure switch to Off.
4. Access the thermocouple calibration:
 - a. In the software select: Utilities → Cell 1 or Cell 2 → Calibrate → Thermocouple
 - b. In the Onboard Display, go to the Calibrate screen and choose “Temperature”.
5. Follow the instructions on the screen. You will be prompted to set the temperature on the dry block to various set points. When the temperature stabilizes, click the “Accept” (software) or “>” (onboard) button.
6. When all steps are complete, you will see the calibration data, including a Pass or Fail.
7. Click the “Save” (software) or “Apply” (onboard) button.

Calibration

UCA Ultrasonic Transducer



Note

The UCA unit should be calibrated initially upon install. It should then be calibrated whenever any part of the test cell, transducers, control card, or software are changed.

1. Assemble the UCA cell (page 33), but do not fill it with cement.
2. Load the cell into the heating jacket and make all necessary connections (page 36).

Make sure the thermocouple is not tightened completely.

3. Slowly turn the Water Supply valve to “FILL”.
4. Watch for water to leak from the thermocouple port. When water starts to leak, immediately tighten the gauge with a wrench to seal the cell. This will ensure that all air has been purged from the cell.
5. Set the Pressure switch to “MANUAL”.
6. Turn the Water Supply valve to “OPERATE”.
7. In the onboard display, set the pressure to 1000 psi (page 31).
8. Access the transducer calibration:
 - a. In the software select: Utilities → Cell 1 or Cell 2 → Calibrate → Ultrasonic Transducer
 - b. In the Onboard Display, go to the Calibrate screen and choose “Transit Time”.
9. The calibration routine will turn on the transmitters and perform the calibration. The transit time should be 15–19 μsec (at $70^\circ \pm 2^\circ\text{F}$). If the transit time is within the acceptable range, click “OK” to save the calibration and continue.



Tip

If the transit time is not within this range, it could be an indication that the transducers are failing or the transducer cables are damaged. Inspect and clean the transducers as well as the transducer cables and connections. Check the transducer springs for weakening or wear. If the transit time is still out of range, then you may need to get replacement parts for the transducers, cables, or springs.

If the software displays an error message, contact OFITE for support.

10. When the calibration is complete, you will see the calibration data, including a Pass or Fail. If the calibration fails, check the system and run the calibration again. If the calibration still fails, contact OFITE support.
11. Click the “Save” (software) or “Apply” (onboard) button.
12. Set the cell pressure to 0 psi (page 31) and set the Pressure switch to “OFF”.

Calibration

SGSM Load Cell

The load cell on the SGSM should be calibrated periodically to ensure accurate readings. The calibration is performed with a dead-weight set.

1. Remove the cover of the SGSM Head Assembly.
2. Remove the torque spring and install the calibration pulley.
3. Connect the wire to the torque spring post and thread it over the calibration pulley.

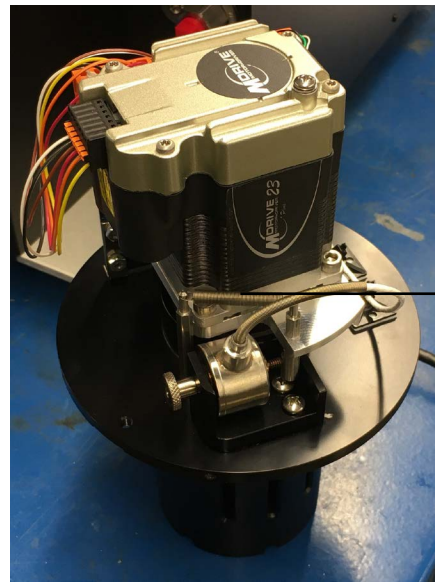

Torque Spring

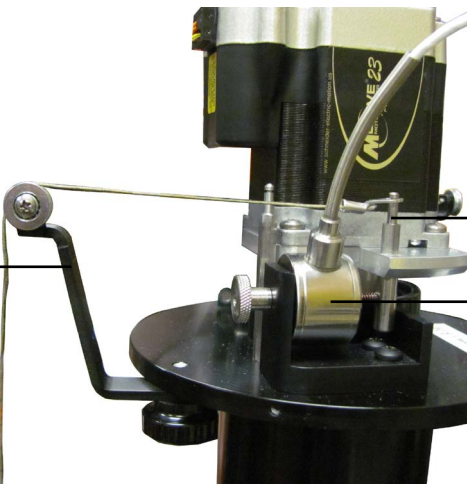

Calibration Pulley

Torque Spring Post

Load Cell

4. Attach the other end of the wire to the hook on the calibration dead-weight holder. Adjust the SGSM so that the weight holder is hanging freely.

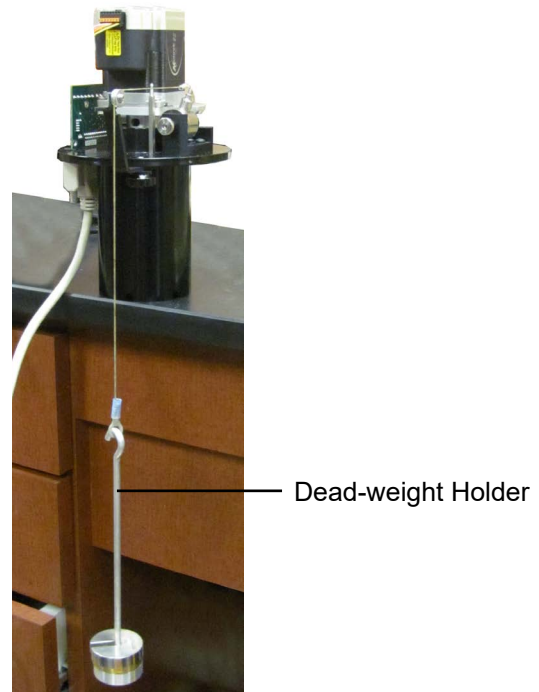

5. Access the load cell calibration:
 - a. In the software click Utilities → Cell 1 (or Cell 2) → Calibrate → Load Cell.
 - b. In the Onboard Display, go to the Calibrate screen and select “Load Cell”.
6. You will be prompted to take a reading with no weight on the transducer. Simply click the “Accept” button.
7. You will now be prompted to add weight to the weight holder. Place the appropriate weight on the holder and click the “Accept” (software) or “>” (onboard) button.
8. Continue adding weight according to the prompts.
9. When the calibration is complete, click the “Save” or “Apply” button.
10. Remove the calibration pulley assembly and reinstall the tension spring between the base spring post and the torque spring post.

Appendix

Electrical System Grounding

Proper grounding protects the equipment operator from the risk of electric shock. The electrical cord provided with this equipment has an equipment grounding conductor and a grounding plug. Observe the following guidelines at all times:

- Always connect the plug to a matching outlet that is properly installed and grounded.
- If an extension cord is necessary, make sure it has three prongs and is compatible with the electrical cord provided with the equipment.
- Do not modify the electrical cord provided with the equipment. If it is not compatible with any available outlets, have a compatible outlet installed by a qualified electrician.
- If the equipment-grounding conductor (solid green or green and yellow) is improperly connected, the operator will be at risk of electrical shock. Never connect it to a live terminal.
- Local codes may require a Ground Fault Interrupt Circuit (GFIC).
- Repair or replace a damaged or worn cord immediately.
- When in doubt, consult an OFITE technician.

Appendix
UCA Cell Assembly
Diagram

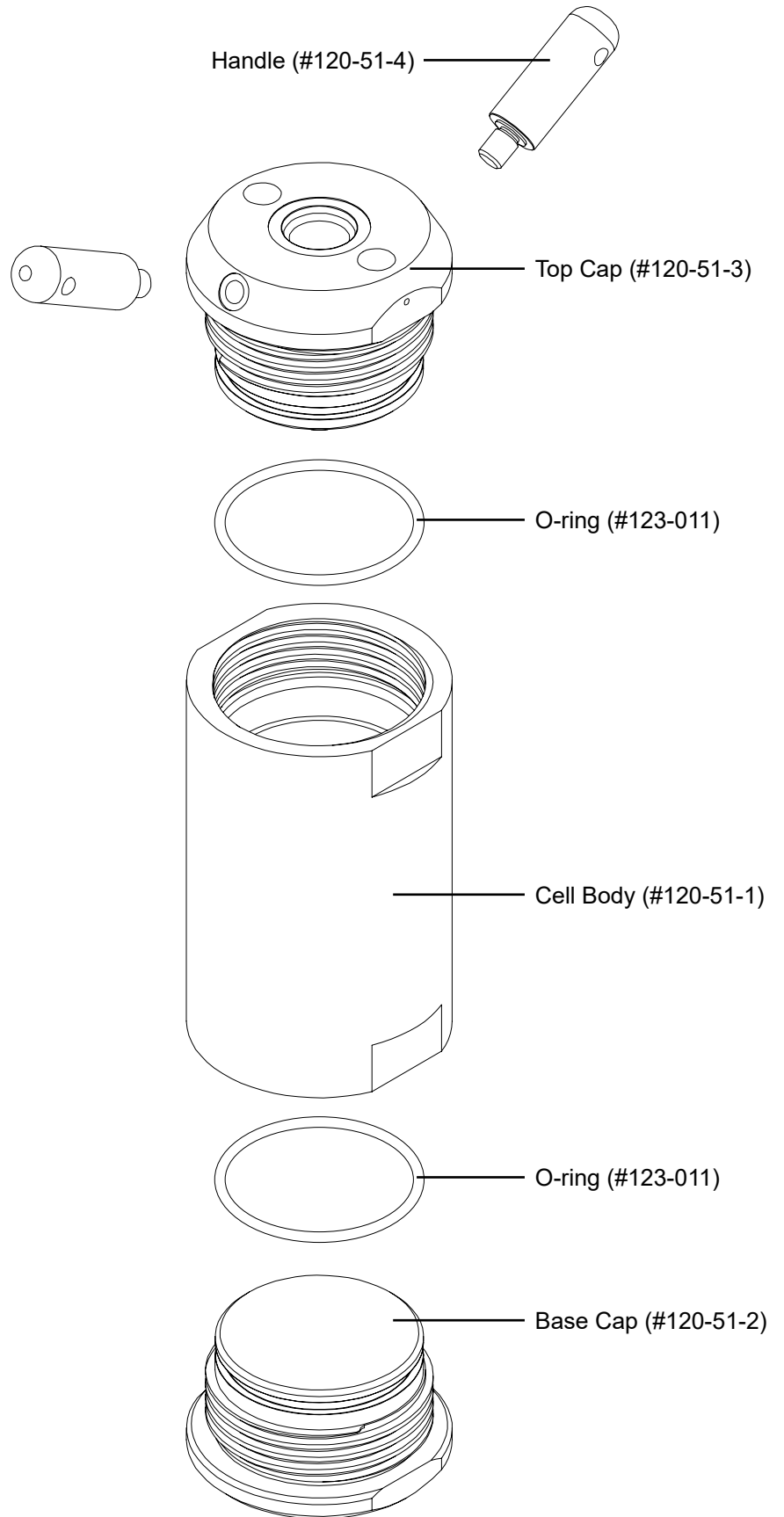

Appendix

SGSM Cell Assembly Diagram

#120-53-006 - Cell Assembly for Low Pressure SGSM

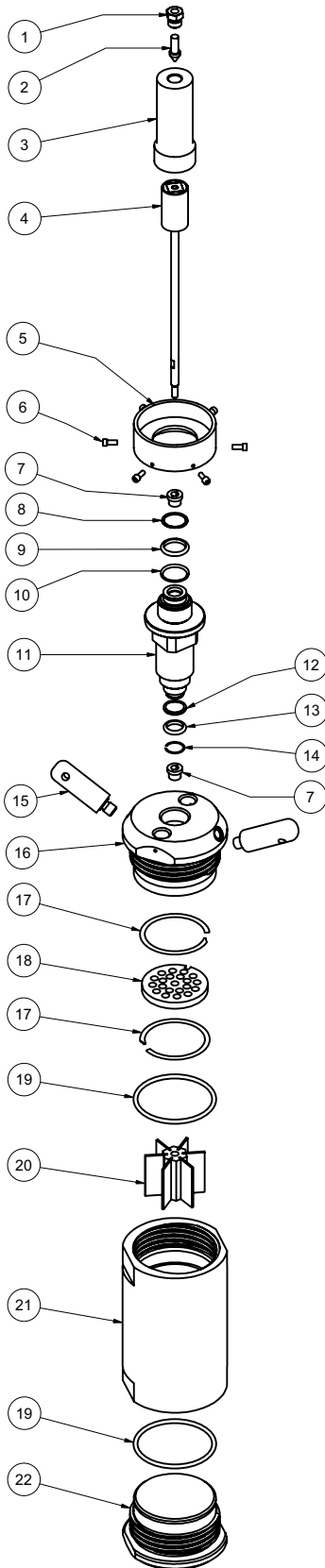

- | | | |
|-----|-------------|--|
| 1. | 122-004-002 | Gland, Medium Pressure |
| 2. | 120-50-058 | Plug, Medium Pressure |
| 3. | 120-53-09 | Cover for Driven Magnet |
| 4. | 120-53-010 | Magnet Shaft Assembly |
| 5. | 120-53-13 | Base Flange |
| 6. | | Screw, Hex Head Cap, #6-32 × 3/8" Long, Qty: 6 |
| 7. | 120-53-42 | Bushing, Qty: 2 |
| 8. | 120-53-82 | Retaining Ring, External |
| 9. | 120-53-32 | O-ring |
| 10. | 120-53-58 | Backup Ring, Upper |
| 11. | 120-58-04 | Mounting Adapter |
| 12. | 120-53-59 | Backup Ring, Lower |
| 13. | 120-53-31 | O-ring |
| 14. | 120-58-05 | Retaining Ring |
| 15. | 120-51-4 | Handle, Qty: 2 |
| 16. | 120-53-03 | Cell Cap |
| 17. | 120-53-38 | Retaining Ring, Internal, Qty: 2 |
| 18. | 120-53-23 | Diaphragm |
| 19. | 123-011 | O-ring, Qty: 2 |
| 20. | 120-53-01 | Vane Paddle Assembly |
| 21. | 120-51-1 | Cell Body |
| 22. | 120-51-2 | Bottom Cap |

Appendix

SGSM Drive Assembly Diagram #120-58-005 - SGSM Drive Assembly

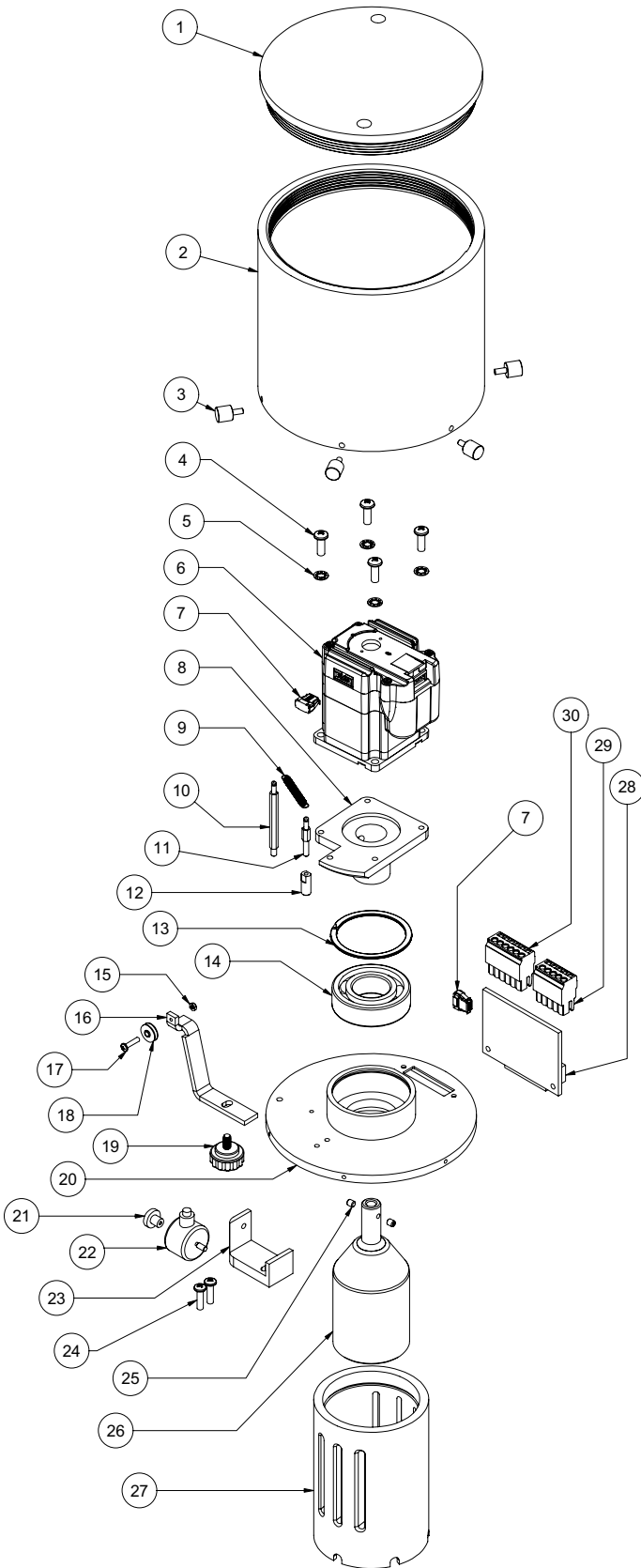

- | | | |
|----|------------|---|
| 1 | 120-53-16 | Cap for Drive Cover |
| 2 | 120-53-15 | Body for Drive Cover |
| 3 | 120-53-57 | Thumb Screw, #6-32 × .375"L,
Qty: 6 |
| 4 | | Screw, Pan Head, #10-32 × .75"L,
Qty: 4 |
| 5 | | Lock Washer, Qty: 4 |
| 6 | 130-76-28 | Motor |
| 7 | 120-53-37 | Connector, Motor to Board, 10
Position, Qty: 2 |
| 8 | 120-53-20 | Flange for Motor Mount |
| 9 | 120-53-33 | Spring for Load Cell |
| 10 | 120-53-22 | Post for Torque Spring, Tall |
| 11 | 120-53-21 | Post for Torque Spring, Short |
| 12 | 120-53-17 | Post for Torque Transducer |
| 13 | 120-53-60 | Retainer Ring, Internal |
| 14 | 120-53-041 | Bearing |
| 15 | | Nut, #4-40, 3/16"W × 1/16"H |
| 16 | 120-58-08 | Calibration Stand |
| 17 | 120-610 | Screw, Phillips, Pan Head,
#4-40 × .375"L |
| 18 | 120-58-11 | Pulley for Calibration Stand |
| 19 | 120-58-10 | Thumb Screw, #10-32 × 3/8"L |
| 20 | 120-58-050 | Drive Base |
| 21 | 120-53-55 | Thumb Screw for Load Cell,
#6-32 × 1/2"L |
| 22 | 120-53-34 | Load Cell |
| 23 | 120-53-18 | Mount for Torque Transducer |
| 24 | | Screw, Pan Head, #8-32 × 1/16" LG,
Qty: 2 |
| 25 | | Set Screw, Hex, Flat Pt, #8-32 × 3/16",
Qty: 2 |
| 26 | 120-53-02 | Magnet for Driver Assembly |
| 27 | 120-58-14 | Support for Drive Assembly |
| 28 | 120-53-77 | A/D Board Assembly |
| 29 | 120-53-29 | Connector for Load Cell, 5 Pin |
| 30 | 120-53-30 | Connector for Motor, 6 Pin |

Warranty and Return Policy

Warranty:

OFI Testing Equipment, Inc. (OFITE) warrants that the products shall be free from liens and defects in title, and shall conform in all respects to the terms of the sales order and the specifications applicable to the products. All products shall be furnished subject to OFITE's standard manufacturing variations and practices. Unless the warranty period is otherwise extended in writing, the following warranty shall apply: if, at any time prior to twelve (12) months from the date of invoice, the products, or any part thereof, do not conform to these warranties or to the specifications applicable thereto, and OFITE is so notified in writing upon discovery, OFITE shall promptly repair or replace the defective products. Notwithstanding the foregoing, OFITE's warranty obligations shall not extend to any use by the buyer of the products in conditions more severe than OFITE's recommendations, nor to any defects which were visually observable by the buyer but which are not promptly brought to OFITE's attention.

In the event that the buyer has purchased installation and commissioning services on applicable products, the above warranty shall extend for an additional period of twelve (12) months from the date of the original warranty expiration for such products.

In the event that OFITE is requested to provide customized research and development for the buyer, OFITE shall use its best efforts but makes no guarantees to the buyer that any products will be provided.

OFITE makes no other warranties or guarantees to the buyer, either express or implied, and the warranties provided in this clause shall be exclusive of any other warranties including ANY IMPLIED OR STATUTORY WARRANTIES OF FITNESS FOR PURPOSE, MERCHANTABILITY, AND OTHER STATUTORY REMEDIES WHICH ARE WAIVED.

This limited warranty does not cover any losses or damages that occur as a result of:

- Improper installation or maintenance of the products
- Misuse
- Neglect
- Adjustment by non-authorized sources
- Improper environment
- Excessive or inadequate heating or air conditioning or electrical power failures, surges, or other irregularities
- Equipment, products, or material not manufactured by OFITE
- Firmware or hardware that have been modified or altered by a third party
- Consumable parts (bearings, accessories, etc.)

Returns and Repairs:

Items being returned must be carefully packaged to prevent damage in shipment and insured against possible damage or loss. OFITE will not be responsible for equipment damaged due to insufficient packaging.

Any non-defective items returned to OFITE within ninety (90) days of invoice are subject to a 15% restocking fee. Items returned must be received by OFITE in original condition for it to be accepted. Reagents and special order items will not be accepted for return or refund.

OFITE employs experienced personnel to service and repair equipment manufactured by us, as well as other companies. To help expedite the repair process, please include a repair form with all equipment sent to OFITE for repair. Be sure to include your name, company name, phone number, email address, detailed description of work to be done, purchase order number, and a shipping address for returning the equipment. All repairs performed as "repair as needed" are subject to the ninety (90) day limited warranty. All "Certified Repairs" are subject to the twelve (12) month limited warranty.

Returns and potential warranty repairs require a Return Material Authorization (RMA) number. An RMA form is available from your sales or service representative.

Please ship all equipment (with the RMA number for returns or warranty repairs) to the following address:

OFI Testing Equipment, Inc.
Attn: Repair Department
11302 Steeplecrest Dr.
Houston, TX 77065
USA

OFITE also offers competitive service contracts for repairing and/or maintaining your lab equipment, including equipment from other manufacturers. For more information about our technical support and repair services, please contact techservice@ofite.com.